



Q/FJHD

企业标准信息

Q/F 1108-2022

Safety rules for the construction and installation of lifts



.....	5
.....	8
1	9
2	10
3	11
4	12
5	12
5.1	12
5.2	14
5.3	15
5.4	16
5.5 ()	17
5.6	17
5.7	18
5.8	19
5.9	20
5.10	20
6	19
6.1	19
6.2	20
6.3	21
6.4	22
7	23
7.1	23
7.2	24
7.3	27
7.4	27
7.5	28
7.6 “ ”	29
7.7	31
7.8	31
8 ()	32
8.1	32
8.2	32
8.3	33
8.4	34

企业标准信息公共服务平台

2022 07 22 19 27



8.5	34
8.6	34
8.7	35
8.8	36
8.9	37
8.10	37
8.11	37
8.12	37
8.13	39
8.14	39
8.15	39
8.16	39
8.17	39
8.18	39
9	40
9.1	40
9.2	41
9.3	41
9.4	41
9.5	41
9.6	41
9.7	42
9.8	43
9.9	44
9.10	45
9.11	48
10	48
10.1	49
10.2	()	49
10.3	49
10.4	50
10.5	51
11	()	51
11.1	51
11.2	52
11.3	()	52
12	53
12.1	53



12.2	()	53
12.3		54
12.4		54
12.5		54
12.6		54
12.7		55
12.8		56
12.9		56
12.10		56
12.11		56
13		57
13.1		57
13.2		58
13.3		58
13.4		59
13.5		60
13.6		61
14		61
14.1		65
14.2		68
15		69
15.1		69
15.2		69
15.3		69
15.4		70
15.5		70
15.6		71
15.7		71
15.8		71
15.9		71
15.10		72
15.11		72
15.12		72
15.13		72
15.14		72
15.15		72
15.16		72
16		72



16.1	72
16.2	73
16.3	74
A	76
B	77
C	79
D	82
E	83
F	106
G	133
H	137
J	143
K	144
L	145
M	151
N	155

企业标准信息
2022 07 22 19 27



GB/T 7588.1/2

企业标准信息

2022

07

22

19

27

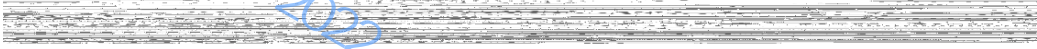

...

GB/T 7588.1/2

2022

07

22

19

27

0

0.1

0.1.1

0.1.2

0.1.2.1

a)

b)

c)

d)

e)

f)

g)

h)

1)

2)

3)

0.1.2.2

a)

b)

c)

()

0.1.2.3

a)

b)

c)

0.2

0.2.1



0.2.3

()

a)

b)

(

)

c)

0.2.4

0.2.5

a)

b)

c)

d)

0.3

0.3.1

a)

b)

c)

d)

0.3.2

0.3.3

0.3.4

0

100

0.3.5

0.3.6

0.3.7

()

0.3.8

0.3.9

a)

300 N

b)

1000N

0.3.10



1

2

企业标准信息

GB/T 786.1

1

GB/T 786.1 2009 ISO 1219-1:2006 IDT

GB/T 3639

GB 4053.1

1

GB 4053.2

2

GB/T 4208

(IP) GB/T 4208 2017 IEC 60529:2013

IDT

GB/T 4728

IEC 60617 database

GB/T 5013.5

450/750V

5

GB/T 5013.5 2008

IEC 60245-5:1994 IDT

GB/T 5023.6

450/750V

6

GB/T 5023.6 2006 IEC 60227-6:2001 IDT

GB/T 5226.1 2019

1

IEC 60204-1:2016

IDT

GB/T 5465.2 2008

2

IEC 60417

DB 2007 IDT

GB/T 7588.2 2020

2

ISO

8100-2:2019 MD

GB 8624

GB/T 8903

GB/T 8903 2018 ISO 4344:2004 MD



GB/T 12668.502 2013 5-2 IEC
 61800-5-2:2007
 IDT
 GB/T 13793
 GB/T 14048.4 2010 4-1
 IEC 60947-4-1:2009 Ed.3.0 MOD
 GB/T 14048.5 2017 5-1
 IEC 60947-5-1:2016 MOD
 GB/T 14048.14 5-5
 GB/T 14048.14 2019 IEC 60947-5-5:2016 IDT
 ISO
 GB/T 15706 2012
 12100:2010 IDT
 GB/T 16895.2 2017 4-42 IEC
 60364-4-42:2010
 IDT
 GB/T 16895.21 2011 4-41 : IEC
 60364-4-41:2005
 IDT
 GB/T 16895.23 2012 6 IEC 60364-6:2006
 IDT
 GB/T 16935.1 1 GB/T
 16935.1 2008
 IEC 60664-1:2007 IDT
 GB/T 17889.2 2012 2 79
 GB/T 18209.3 273
 GB/T
 18209.3 2010 IEC 61310-3:2007 IDT
 GB/T 18775
 GB/T 21711.1 1 GB/T 21711.1
 2008 IEC
 61810-1:2003 IDT
 GB/T 23821 2009 ISO
 13857:2008 IDT
 GB/T 24475



GB/T 24476 2017

GB/T 24480

GB/T 24807

GB/T 24808

GB/T 27903

GB/T 32957

GB 50017

GA 494

JB/T 8734.6

450/750V

6

IEC 61810-3

[Electromechanical elementary relays - Part 3: Relays with forcibly guided (mechanically linked) contacts]

EN 50274

Low voltage switchgear and controlgear assemblies - Protection against electric shock -

Protection against unintentional direct contact with hazardous live parts

3

GB/T 7024

3.1 traction drive lift

3.2 () positive drive lift

3.3 non-commercial vehicle lift

3.4 pulley room

3.5 available car area

1m

3.6 re-leveling

()



3.7 minimum breaking load of a rope
(mm²) (N/mm²)

3.8 safety rope
()

3.9 user

3.10 passenger

3.11 authorized and instructed user

a)

b)

3.12 lift machine

3.13 balancing weight

3.14 electric safety chain

3.15 inspection trap

3.16 emergency door to the well
11m

3.17 laminated glass

3.18 unintended car movement

4

4.1

(SI)

4.2

5

5.1

5.1.1

5.1.2

()

()

5.2

5.2.1

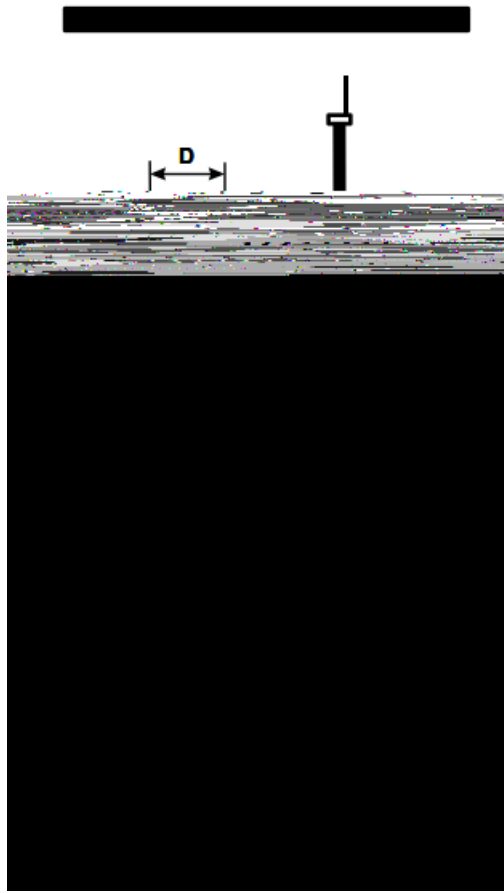



1

5.3

企业标准信息

5.3.1

5.3.1.1

300N

5cm²

a)

b)

15mm

5.3.1.2

5.2.1.2

5.3.2

5.3.2.1

(N) [G()G2.3 G2.4]

5.3.2.2

4g_n(P+Q)

P—

)

kg

Q—

kg

9.81 m/s²

g_n—

5.3.2.3

() 4

4g_n(P+qQ)

4g_nqP

:

q—

5.3.3

6.3.1 ()6.4.1
G5.1

5.4

5.4.1

5.4.2



5.4.3

a) 50mm, 25mm 1/2

b) 5cm² 300N

1) 10mm 5mm 2mm
2) 75°

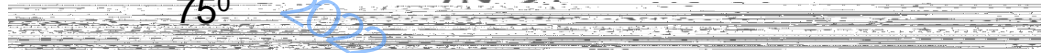

d) 1) 2) 600

5.5 20mm ()

()

5000N/m²

a) ()

b) ()

5.6

5.6.1 () 0.30m 2.50m ()

0.10m GB I2265.1—1997 4.5.1

5.6.2

GB I2265.1—1997 4.5.1

5.6.2.1 ()

2.50m

5.6.2.2 [5.2.2.2 ()]

0.50m

0.10m



5.7

5.7.1

K()

5.7.1.1

a) $0.1+0.035 v^2(m)$

注: $0.035 v^2$ 表示对应于15%额定速度 v 时的重力制停距离的一半。即 $\frac{1}{2} \times \frac{(1.15v)^2}{2g_H} = 0.0337 v^2$,

圆整为 $0.035 v^2$ 。

b) ~~8.13.2 [5.7.1.1c]~~

) $1.0+0.035 v^2(m)$

c) 1) [2]

2) $0.3+0.035 v^2(m)$

$0.1+0.035 v^2(m)$

d) $0.50m \times 0.60m \times 0.80m$ ()

0.15 m

5.7.1.2

$0.1+0.035 v^2(m)$

5.7.1.3

5.7.1.2

2022 07 22

12.8

5.7.1.1

a) $4m/s$ $1/2$ 0.25m

b) $4m/s$ $1/3$ 0.28m

5.7.1.4

$0.035 v^2$ ()
 $1/500$ 0.20m

5.7.2

5.7.2.1

0.50m

5.7.2.2

a) $8.13.2$ [5.7.2.2b)

] (1m

b)



1)] 0.30 m [2]

2) 0.10m

c) 0.50m×0.60m×0.80m (

) 0.15 m

5.7.2.3 ()
0.30 m

5.7.3

5.7.3.1

5.7.3.2 2.50m 5.2.2

5.7.3.3

a)

0.50m×0.60m×1.0m

b)

0.15m

0.50m

0.10m

1)

2)

c)

0.30m

b)1) b)2)

5.7.3.4

a)

14.2.2 15.7

b)

(13.6.2)

c)

(5.9)

5.8



5.2.1.2

a)

b)

1.50m

(5.2.1.2)

5.9

1m

50 lx

0.50m

5.2.1.2

5.10

14.2.3.2

14.2.3.3

6

6.1

6.1.1

()

(

a)

b)

c)

6.1.2

()

6.1.3

a)

b)

6.2

6.2.1

a)

b)

6.2.2

- a) 4m
- b)
- c) 1.50m 650 750
- d) 0.35m 25mm 0.15m 1500N

- e)
- f) 1.50m

- 6.3
- 6.3.1
- 6.3.1.1
- 6.3.1.2
- 6.3.2
- 6.3.2.1

- a) 2m
- 1) 0.70m
- 2) 0.50m
- b) 0.50m×0.60m
- (12.5.1) 1.80m
- 6.3.2.2 0.50m
- 6.3.2.1 0.40m

- a)
- b) 0.30m
- 6.3.2.3
- 6.3.2.4 0.50m



6.3.3.2

0.80m×0.80m

0.20m×0.2m

1000N

(

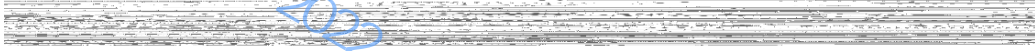

企业标准信息

2022 07 22 19 27

2022 07 22 19 27



6.4.2.2.2

6.3.2.1 6.3.2.2

6.4.3

6.4.3.1

0.60m

1.40m

6.4.3.2

0.80m×0.80m

0.20m×0.20m 1000N

6.4.3.3

()

6.4.4

50mm

6.4.5

14.2.2 15.4.4

6.4.6

6.4.7

100 lx

13.6.1

13.6.2

6.3.6

7

7.1

6mm

8mm

10mm



7.2

7.2.1

7.2.2

GA 109

7.2.3

7.2.3.1

a 300 N

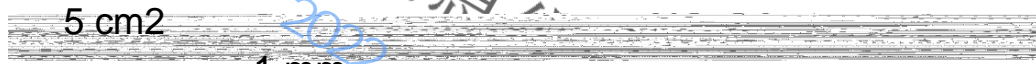

1

1 mm

2

15 mm

b 1000 N

100 cm²

[7.1 10 mm

7.7.3.1]

a

b

7.2.3.2

)

7.1

150N

6mm

(

a) 30mm

b) 45mm

7.2.3.3

/

7.2.3.4

7.2.3.5

a)

b)

c) [(8+0.76+8)mm]

7.2.3.6

7.6.2

a)

b)

1.10m

c)

d)

7.2.3.7

7 /



7.2.3.8

150 mm

a

J

7

1

2

0.12 m

3

4

b

J 79

7.6.2 a

7

1

2

2 mm

企业标准信息

2022

07

22

19

27

2022

07

22

19

27



7

	800 nm	800 nm	500 nm	500 nm
	1.0 ± 0.1 m		1.0 ± 0.1 m	
[7a]				
[7b]	×	×		×
[7c]	×	×		×
[7d]	×		×	
1 m [7e]	×	×		×
1 m [7f]	×		×	
150 nm [7g]	×			
7.6 2	×	×		
×				

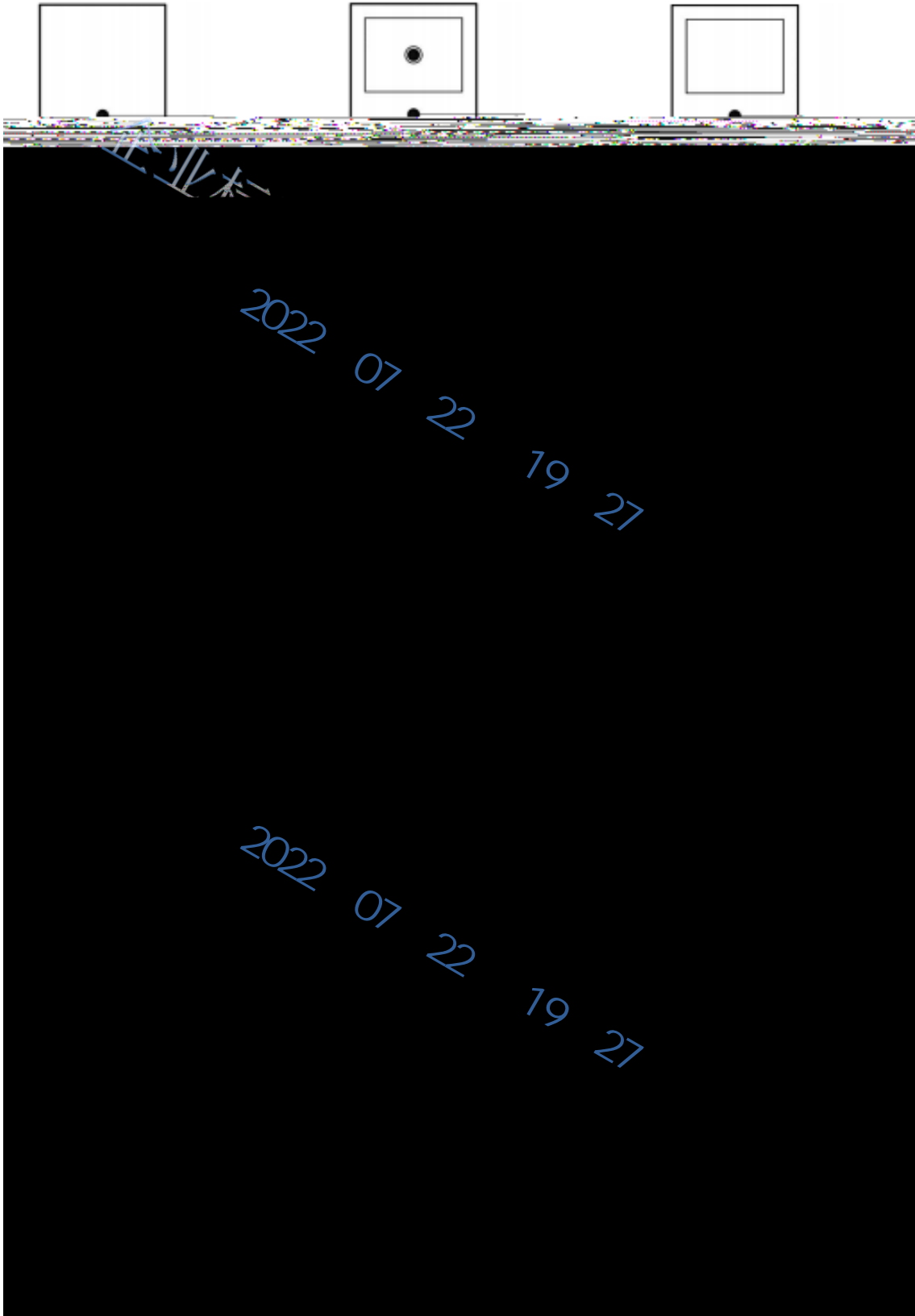

2

1.00 m

± 0.10m



g)

[7a 7b)]

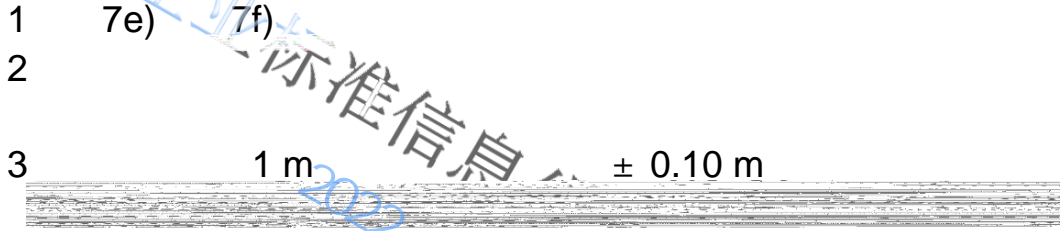

7

7.3

7.3.1

2m

7.3.2

50mm

7.4

7.4.1

7.4.2

7.4.2.1

7.4.2.2

7.4.2.3

7.4.3

7.4.3.1

7.4.3.2

7.4.3.3

7.4.3.4

7.5

7.5.1

25

8



3mm

B()

7.5.2

7.5.2.1

7.5.2.1.1

7.5.2.1.1.1

150N

1/3

7.5.2.1.1.2

10J

a)

25mm

b)

50mm

25N/mm

7.5.2.1.1.3

(8.7.2.1.1.3)

50mm

7.5.2.1.1.2

4J

7.5.2.1.1.4

7.5.2.1.1.1

7.5.2.1.1.2

7.5.2.1.1.5

150N

()

100mm

7.5.2.1.2

)

7.5.2.1.1.2

10J

0.3m/s

7.5.2.2



a)

b)

0.3 m/s

c)

8.6.1

2/3

d)

7.5.2.3

7.6

“ ”

7.6.1

50 1x

(0.2.5)

7.6.2 “ ”

a) b)

a)

7.2.3.1

1)

2)

6mm

3)

0.015m²

0.01m²

4)

60mm

150mm

80mm

1m

b)

“ ”

7.7

7.7.1

()

0.2m

0.35m

7.7.2

7.7.2.1

7.7.2.2

7.7.2.2



a) 14.2.1.2

b) 8.4.3, 8.14 14.2.1.5

1.65m

1)

2 m

2)

7.7.3

7.7.1

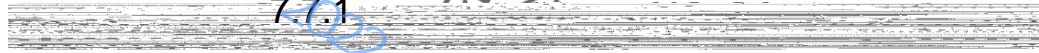

7.7.3.1

14.1.2

7.7.3.1.1

7mm

3

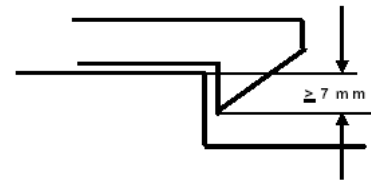
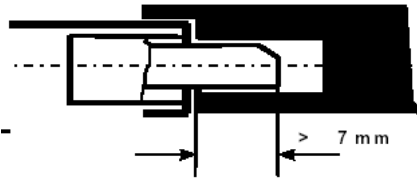

3

7.7.3.1.2

7.7.3.1.3

7.7.3.1.4

7.7.3.1.5

300N

7.7.3.1.6

F()FI

a)

1000N

b)

3000N

7.7.3.1.7



()

(

)

7.7.3.1.8

7.7.3.1.9

7.7.3.1.10

7.7.3.2

B

()

7.7.3.3

F1

7.7.4

7.7.4.1

14.1.2

7.7.2

7.7.4.2

7.7.4.3

7.7.5

7.7.5.1

7.7.5.2

7.7.6

7.7.6.1

a)7.7.4.1 7.7.4.2

b)

7.7.6.2

()

14.1.2



7.8

8

8.1

8.1.1

8.1.2

8.2

8.2.1

()
企业标准信息

2m

2m

2022 07 22

1

19

1m

27

1

5

14.2.5

1

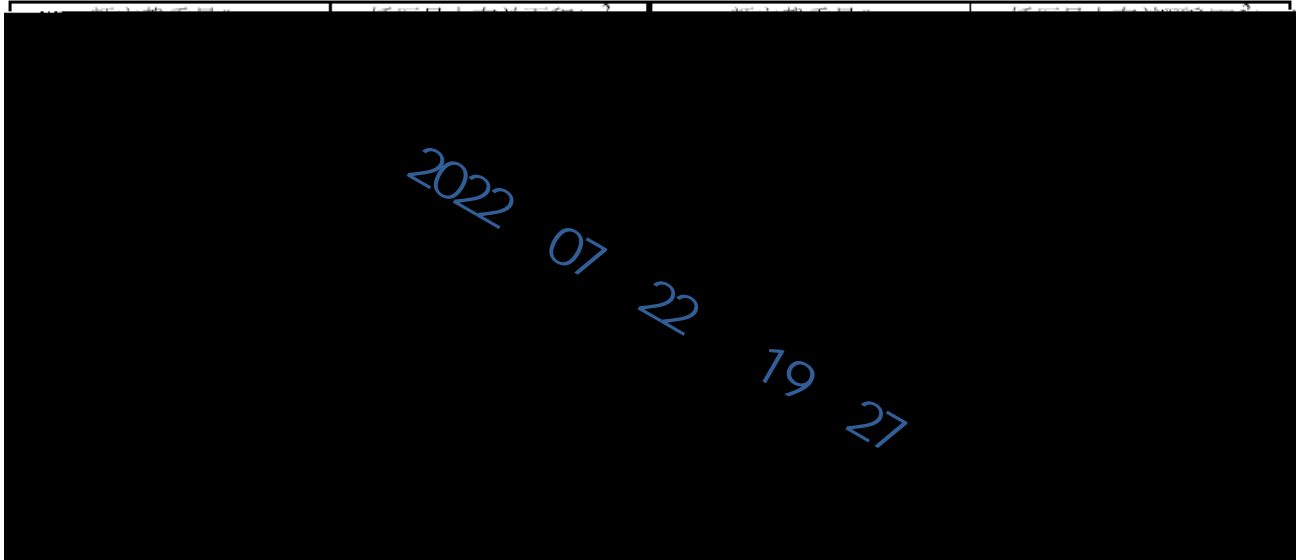

2022 07 22 19 27

8.2.2

1

1

1

“ ”

a)

1



(
)

b)

14.2.5

c)

(15.5.3)

d)

e)

a) b) c) d) e)

D()D2h)

D2j)

D2l)

200kg/m²

8.2.3

a) 75/

b) 2

2

乘客人数/人	轿厢最小有效面积/m ²	乘客人数/人	轿厢最小有效面积/m ²

8.3

8.3.1

a)

b)

c)

8.3.2



8.3.2.1

300N

5cm²

a)

b)

15mm

8.3.2.2

J1

J

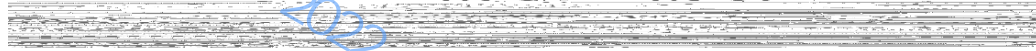

1.10m

0.90m 1.10m

8.3.2.3

8.3.2.4

a)

b)

c) [(8+0.76+8)mm]

8.3.2.5

8.13

8.3.3

8.4

8.4.1

60°

8.4.2

8.4.3

20mm

0.75 m

(14.2.1.5)

0.10m

8.5

8.6

8.6.1

10mm

60mm

8.6.2

8.6.3

6mm



8mm

10mm

8.6.1

8.6.4

8.6.5

[7.6.2a)]

7.6.2a)

8.6.6

7.4

8.6.7

8.6.7.1

300N

5cm²

a)

b)

15mm

c)

8.6.7.2

7.6.2

J2

J

8.6.7.3

8.6.7.4

a)

b)

c) [

(8+0.76+8)mm]

8.6.7.5

7.6.2

a)

b)

1.10m

c)

d)

8.7

8.7.1

3 mm



8.6.1

8.7.2

8.7.2.1

8.7.2.1.1

8.7.2.1.1.1

1/3

8.7.2.1.1.2

10J

150N

a)

b)

7.5.2.1.1.2 .

8.7.2.1.1.3

25mm

50mm

50mm

8.7.2.1.1.2

4J

8.7.2.1.1.4

150 N

()

100mm

8.7.2.1.1.5

15 mm

8.7.2.1.2

)

7.5.2.1.1.2

0.3m/s

10J

8.7.2.2

a)

b)

0.3 m/s

c)

8.6.1

d)

2/3

8.8

8.9

8.9.1 7.7.2.2 ()

8.9.2

14.1.2

8.9.1

8.9.3

[11.2.1c]
(7.7.3.1 7.7.3.3)

8.10

8.10.1

a) 8.9.2

1) ()

2)

b) 11.2.1c)

8.10.2

()

8.9.2

a)

b)

8.11

8.11.1

7.7.1



8.12

8.12.1

12.5

8.12.2

0.35m×0.50m

8.12.3

0.75m(

5.2.2.1.2)

1.80m

0.35m

8.12.4

8.3.2 8.3.3

8.12.4.1

8.12.4.1.1

B

8.12.4.1.2

B

()

()

8.12.4.2

8.12.4.1

14.1.2

8.13

8.3

8.13.1

0.20m×0.20m

1000N

8.13.2

0.12m²

0.25m

8.13.3

0.30m

0.30m

8.13.3.1

0.10m

8.13.3.2



a) 0.85m 0.70m
 b) 0.85m 1.10m
 8.13.3.3 [()]

0.10m

8.13.3.4

8.13.3.5

0.15 m

8.13.4

8.13.5

8.13.6

()

9.7

8.14

14.2.1.5)

8.15

a) 14.2.1.3 ()

b) 14.2.2 15.3

c) 13.6.2

8.16

8.16.1

8.16.2

1

50

8.16.3

10mm

8.17

8.17.1

50

lx

50 lx

8.17.2

8.17.3

7.8

8.17.4

1W

1h

8.17.5

8.17.4

14.2.3



8.18

12.2.1

8.18.1

()

a)

b)

1m/s

8.18.2

() ()

9.7

9

9.1

9.1.1

()

9.1.2

a)

8mm

b)

1)

1570MPa 1770MPa

2)

1370MPa

1770MPa

c)

()

GB 8903

9.1.3

9.1.4

9.2

9.2.1

40

9.2.2

N()

a)

b)

16

c)

12

(N)

(N)

9.2.3

9.2.3.1

80

9.2.3.1

()

()



9.2.3.2

9.2.4

10

9.2.2

9.2.5

()

80

9.3

a)

125 8.2.1 8.2.2

b)

()

c)

M()

9.4

9.4.1 12.2.1b)

9.4.2

9.4.3

9.4.4

() 4°

9.5

9.5.1

9.5.1.1

9.5.1.2

9.5.2

9.5.3

14.1.2

9.5.4

9.6

9.6.1

a)

b)

30



c) 9.7
 d)
 e) 14.1.2
 9.6.2 3.5 m/s 9.6.1

企业标准信息
 2022 07 22 19

14.1.2
 9.7
 9.7.1 3

a)
 b)
 c)
 3 19

曳引轮、滑轮及链轮的位置		根据9.7.1的危险		
		a	b	c
轿厢上	轿顶上	×	×	×
	轿底下		×	×
对重或平衡重上			×	×
机房内		× ²⁾	×	× ¹⁾
滑轮室内			×	



9.7.2
 GB12265.1—1997 4

a)
 b)
 c)
 9.8
 9.8.1
 9.8.1.1

9.10

9.8.1.2 5.5b)

)

()
()
()

9.8.3.1
)



c) 1m/s 1.5m/s
 d)对于额定速度大于1m/s的渐进式安全钳为 $1.25v + \frac{0.25}{v}$ m/s)。

1m/s d)
 9.9.2 9.9.1
 9.9.3 () 9.9.1

9.9.4

a)
 b)300N

a)
 b) M2.2.1

9.9.5
 9.9.6
 9.9.6.1
 9.9.6.2

8

$\mu_{max}=0.2$
 6mm

9.9.6.3
 9.9.6.4 30
 9.9.6.5 ()
 9.9.6.6

9.9.6.7
 9.9.7

(F3.2.4.1)

9.9.8
 9.9.8.1
 9.9.8.2
 9.9.8.3 9.9.8.2

a) () 9.9.9

b)

c) ()



9.9.9

9.9.1

9.9.10

9.9.11

9.9.11.1

14.1.2

1m/s

9.9.11.2

(9.8.5.2)

14.1.2

14.2.1.4c)5)

9.9.11.3

14.1.2

9.9.12

F4

9.10

9.10.1

115

9.9.3

9.10.2

9.10.1

9.10.3

9.10.4

a)

b)

c)

()

d)

(

)

9.10.5

14.1.2

9.10.6

9.10.7

9.10.8

9.10.9

1g_n

企业标准信息

2022 07

22

19

27

2022

07

22

19

27



9.10.10

a) 9.9

b) 9.9.1 9.9.2 9.9.3 9.9.7 9.9.8.1 9.9.9 9.9.11.2
9.9.4 9.9.6.1 9.9.6.2 9.9.6.5 9.9.10 9.9.11.3

9.10.11

F7

9.11

9.11.1

14.2.1.2

9.11.3 9.11.4

/

9.11.2

9.11.3

12.4.2

15

24

9.11.4

- a
- b
- c
- d
- e

--



--

企业标准信息

2022

07

22

19

27

2022

07

22

19

27



9.11.6

--

1 gn

--

9.11.7

7.7.1

14.1.2

9.11.8

14.1.2

9.11.7

9.11.9

9.11.10

9.11.11

9.11.12

9.11.13

F8

10

10.1

10.1.1

a)

()

b)

1)

2)

3)

G2

G3

G4

(0.2.5)

G

10.1.2

10.1.2.1

$$\sigma_{perm} = \frac{R_m}{S_t}$$

perm —

MPa

R_m —

MPa

S_t —

4

4

载荷情况	延伸率(A_5)	安全系数
正常使用	$A_5 \geq 12\%$	2.25
	$8\% \leq A_5 < 12\%$	3.75
安全钳动作	$A_5 \geq 12\%$	1.8
	$8\% \leq A_5 < 12\%$	3.0

8
JG/T 5072.1 (MPa) 5
5

载荷情况	R_m MPa		
	370	440	520
正常使用	165	195	230
安全钳动作	205	244	290

10.1.2.2 “T”

a) ()

5mm

b) ()

10mm

10.1.3

10.2 ()

10.2.1 ()

10.2.2

a) 0.4m/s

b)

10.2.3 ()

10.3

10.3.1



10.3.5

10.3.6

F5

10.4

L()

10.4.1

10.4.1.1

10.4.1.1.1

115

0.135 ²(m)

65mm

注: $\frac{2 \times (1.15v)^2}{2g_n} = 0.1348v^2$, 四舍五入到 $0.135v^2$

10.4.1.1.2

) 2.5 4

10.4.1.1.1

10.4.1.2

10.4.1.2.1

a)

115

1g_n

b)2.5g_n

0.04s

c)

1 m/s

d)

10.4.1.2.2

5.7.1.1

5.7.1.2

5.7.2.2

5.7.2.3

5.7.3.3

”

90

10.4.2 ()

10.4.3

10.4.3.1

115

0.067 4 ²(m)

10.4.3.2

12.8

10.4.3.1

()

a)

4m/s

10.4.3.1

50

0.42m

b)

4m/s

10.4.3.1

1/3

0.54 m

10.4.3.3

a)

115

1g_n

b)2.5 g_n

0.04s

c)

10.4.3.4



14.1.2

10.4.3.5

10.5

10.5.1

企业标准信息

10.5.2

10.5.2.1

10.5.2.2

a)

b)

c)

10.5.2.3

a)

b)

14.1.2

10.5.3

10.5.3.1

a)

12.4.2.3.2

b)

1) a)

2)

14.1.2

12.4.2.3.1

12.7.1

13.2.1.1

c)

10.5.3.2

11

()

11.1

11.2

4 5

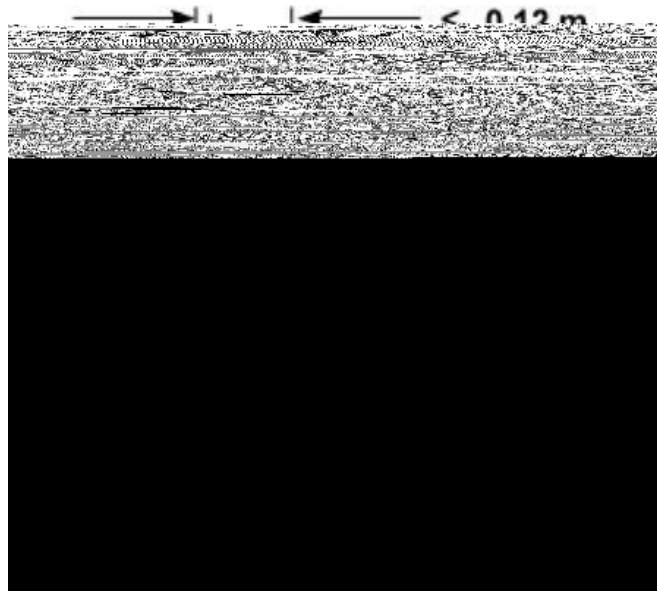

4

11.2.1

0.15 m

a)

0.20m

0.50m

b)

0.20m

c)

7.7.2.2

14.1.2

11.2.2

35mm

11.2.3



12

12.1

12.2

12.2.1

a)

b)

1)

2)

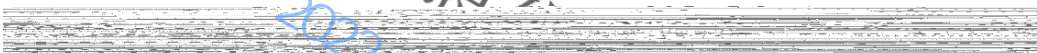

0.63m/s

12.2.2

(12.4.1.2)

12.3

9.7

12.4

12.4.1

12.4.1.1

a)

b)

12.4.1.2

— ()

()

12.4.2 —

12.4.2.1

125

12.4.2.2

12.4.2.3

12.4.2.3.1



12.4.2.3.2

12.4.2.3.3

12.4.2.4 (12.5.1)

12.4.2.5

12.4.2.6

12.4.2.7

12.5

12.5.1

400N

12.5.1.1

14.1.2

12.5.1.2

12.5.2

12.5.1

400N

14.2.1.4

12.6

(92)

105

105

a) [14.2.1.2b)]

b) [14.2.1.2c)]

c) [14.2.1.3d)]

d) [14.2.1.4e)]

e) [14.2.1.5c)]

12.7

14.1.2

12.7.1

企业标准信息公共服务平台
2022 07 22 19 27

12.7.2
12.7.2.1

—

- a)
- b)
- c)

b) c)
()
12.7.2.2

- a) 12.7.2.1
- b)
- 1)

- 2)
- 3)

)
12.7.3

a)

b)
1) ()

- 2)
- 3)

(



12.7.4 12.7.2.2b)2) 12.7.3b)2) 12.7.2.2b)3)

12.7.3b)3) 14.1.2.3

14.1.1 12.7.3a)

12.8

12.8.1 10.4.3.2

12.8.2

12.8.3

12.8.4

a)

b)

c)

14.1.2

12.8.5

14.1.2

12.9

14.1.2

9.5.3

12.10

12.10.1

a)

b)

12.10.2

a)45s

b) 10s 10s

20s

12.10.3

12.10.4

12.11



- a)
- b)
- c)
- d)
- e)

9.7

12.12

± 20 mm

± 10 mm

± 10 mm

± 20 mm



13

- 13.1
- 13.1.1
- 13.1.1.1

- a)
- b)

13.1.1.2

13.1.1.1

13.1.1.3

EN 12015 EN 12016

13.1.2

IP2X

13.1.3

(HD384.6.61S1)

6

6

V	() V	$/M$
500	250	0.25
500	500	0.50
500	1000	1.00

13.1.4



250V

13.1.5

13.2

13.2.1

13.2.1.1

GB 14048.4

a)AC-3

b)DC-3

12.7

)

10

13.2.1.2

GBI4048.5

a)AC-15

b)DC-13

13.2.1.3

13.2.1.1

13.2.1.2

a) b)

13.1.1.1

a)

()

b)

()

13.2.2

13.2.2.1

13.2.1.2

13.2.1.3

13.2.2.2

14.1.1.1f)

13.2.2.3

()

14.1.2.2.3

()

13.2.1.1

13.2.1.2

13.2.2.1

GB I4048.4

GB I4048.5

H(

) H1(3.6)

13.3

13.3.1

13.3.2

(13.3.3

)

13.3.3

13.3.6

13.3.4

13.3.2

13.3.3

13.3.5



13.3.6

13.4

13.4.1

a)

b)

c)

d)

e)

f)

13.4.2 13.4.1

企业标准信息

()

2022 07 22 19 27

14.1.2

13.4.3

13.4.4

2022 07 22 19 27

13.5

13.5.1

13.1.1.2

GB 5023.3 GB

5013.4

13.5.1.1

GB 5023.3—1997

2

[227IEC01(BV)]

3

[227IEC02(RV)]

4 [227IEC05(BV)]

5

[227IEC06(RV)]

()



GB 5023.1—1997 A

13.5.1.2

GB 5023.4—1997 2

()

13.5.1.3

GB 5013.4—1997 3

[245IEC53(YZ)]

GB

5023.5—1997 5

[227IEC52(RVV)]

GB 5013.4—1997 5

[245IEC66(YCW)]

13.5.1.2

(

)

GB 5023.6

GB 5013.5

13.5.1.4

13.5.1.1

13.5.1.2

13.5.1.3

a)

1)

100VA

2) ()

()

50V

b)

1)

2)

13.5.2

0.75mm²

13.5.3

13.5.3.1

13.5.3.2 13.1.2

13.5.3.3

50V

13.5.3.4

13.5.3.5

13.5.3.6



13.5.4

13.6

13.6.1

13.4

13.6.2

13.6.1

a) 2P+PE 250V

b) GBI4821.1

13.6.3

13.6.3.1

13.6.3.2

()

13.6.3.3 13.6.3.1 13.6.3.2

14

14.1

14.1.1

14.1.1.1

14.1.1.2 ()

H

14.1.2.3

14.1.1.1

a)

b)

c) ()

d)

e)



- f)
- g)
- h)
- i)
- j)

14.1.1.2 14.1.2.2

14.1.1.3

- a)
- b)

14.1.2

14.1.2.1

14.1.2.1.1 A()

14.1.2.4

a) 14.1.2.2 12.7

b) 14.1.2.3

1) 14.1.2.2 12.7

2) 14.1.2.2

3) H

14.1.2.1.2 ()

14.1.2.1.3 (14.2.1.2 14.2.1.4 14.2.1.5)

14.1.2.3

14.1.2.1.4

14.1.2.1.5

14.1.2.1.6

14.1.2.1.7

企业标准信息

2022 07 22 19 27

2022 07 22 19 27



14.1.2.1.8

14.1.2.2

14.1.2.2.1

企业标准信息公共服务平台
2022 07 22 19 27

14.1.2.2.2
250V

IP4X
IP4X

500 V

GBI4048.5

a)AC—15

b)DC—13

14.1.2.2.3

IP4X

3mm,

4mm

4mm

IP4X

3mm

14.1.2.2.4

2

mm

14.1.2.2.5

14.1.2.3

14.1.2.3.1

14.1.2.3.2

14.1.2.3.2.1

2022 07 22 19 27

14.1.1

6

()

()

故障 1

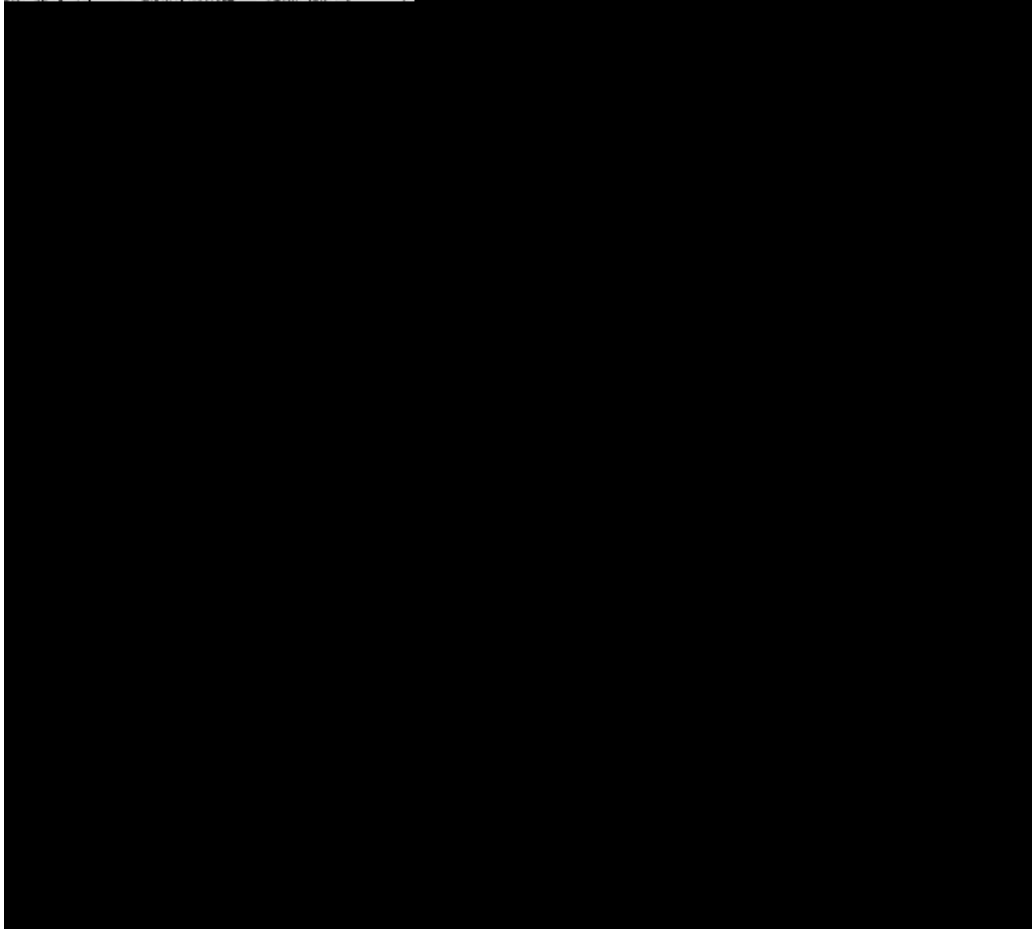

6

14.1.2.3.2.2



14.1.2.3.2.4

14.1.2.3.2.1

14.1.2.3.2.3

14.1.2.3.2.5

14.1.2.3.3

F6

14.1.2.4

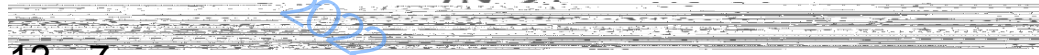

12 7

14.1.2.5

F6.3.1.1

14.2

14.2.1

14.2.1.1

14.2.1.2

7.7.2.2a)

a) (7.7.1)

1)

2) 14.1.2.2

14.1.2.3

3)



14.1.2

4)

b)

1)

2)

c)

0.8m/s

0.8m/s

0.3 m/s

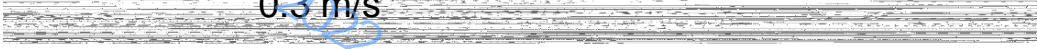

企业标准信息
2022 07 22 19 27



a)

b)

c)

14.1.2

1)9.8.8

2)9.9.11.1 9.9.11.2

3)9.10.5

4)10.5

5)10.4.3.4

d)

e)

0.63m/s

14.2.1.5

7.7.2.2b)

a)

1.65 m

b)

14.1.2

c)

0.3 m/s

d)

e)

f)



i) 114.2.2.1e]

14.2.2

14.2.2.1

a) [5.7.3.4a)]

b) (6.4.5)

c) (8.15)

1 m

1 m

d) [14.2.1.3c)]

e) [14.2.1.5i)]

1 m

(15.2.3.1)

14.2.2.2

14.1.2

14.2.2.3

14.2.3

14.2.3.1

14.2.3.2

8.17.4

14.2.3.2

14.2.3.3

14.2.3.4

30m

8.17.4

14.2.4

14.2.4.1

2 s

14.2.4.2

2 s

14.2.4.3

14.2.5

14.2.5.1

14.2.5.2

10

75 kg



14.2.5.3

- a) ()
- b)
- c)
- d) 7.7.2.1 7.7.3.1

15

15.1

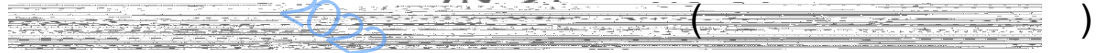

()

15.2

15.2.1

8.2.3

“.....kg.....”

a)10mm

b)7 mm

15.2.2

15.2.3

15.2.3.1

()

“ ”

()



“ ”

15.2.3.2

a)

2 1 0 1 2 3

b)



15.2.4

a)

b)



c)

15.3

a)

b)

c)

d)

15.4

15.4.1

“

——”

“

——

”

15.4.2

()

15.4.3

15.4.3.1

15.4.3.2

15.4.4

“ ”

15.4.5

(6.3.7)

15.5

15.5.1

“

——

”

15.5.2

“ ”

15.5.3

企业标准信息

2022 07 22 19 27

2022 07 22 19 27

15.6

a)

b)

c)

15.7



15.16

- a)
- b)
- c)

15.17

F8.1

- a
- b
- c

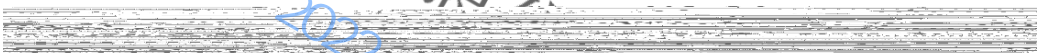

16

16.1

16.1.1

C()

16.1.2

D

C

16.1.3

- a)
- b)
- c)
- d)
- e)
- f)
- g)
- h)

()

A A1

9.11.7	
9.11.8	



16.2

a)

1)

2)

3)

()

4)

(16.1.3)

5)

6)

(GB/T 4728)

b)

1)

[E()]

2)

3)

16.3

16.3.1

a)

b)

c)

G .

企业标准信息

2022 07 22 19 27

2022 07 22 19 27

2022 07 22 19 27



16.3.3.1

E

16.3.3.2

E

企业标准信息

2022 07 22 19 27

2022 07 22 19 27



A

()

A1

A1

A1

5.2.2.2.2

5.7.3.4a)

6.4.5

7.7.3.1

7.7.4.1

7.7.6.2

8.9.2

8.12.4.2

8.15b)

9.5.3

)

9.6.1e)

9.6.2

9.8.8

9.9.11.1

9.9.11.2

9.9.11.3

9.10.5

10.4.3.4

10.5.2.3b)

10.5.3.1b)2)

11.2.1c)

12.5.1.1

12.8.4c)

12.8.5

12.9

13.4.2

14.2.1.2a)2)

企业标准信息

2022 07 22 19 27

2022 07 22 19 27

(

()

()



14.2.1.2a)3)

()

14.2.1.3c)

14.2.1.5b)

14.2.1.5i)

企业标准信息

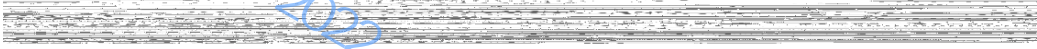

2022 07 22 19 27

2022 07 22 19 27



B

()

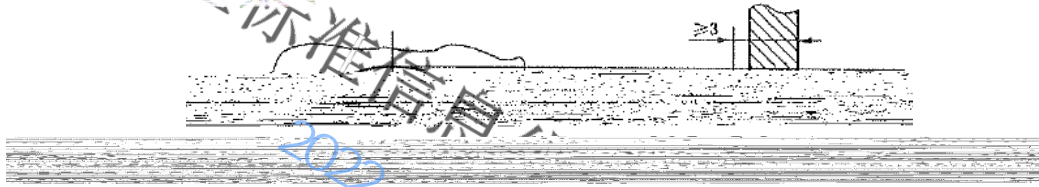

B1

2022 07 22 19 27

c

()

.

C1

C2

()

()

()

(6.2)

C3



(11.2.3)

() () ()

企业标准信息

(N)

()

C4

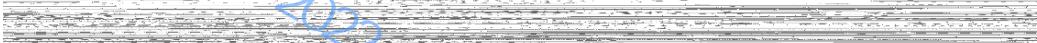

a)

b)

GB/T 4728

C5

()

2022 07 22 19 27



D

()

企业标准信息公共服务平台

D1

- a)
- b)
- c)
- d)

(C)

D2

- a)
- b)
- c)

(7.7)
(A)

[16.2a)];

- d)

(12.4);

125

- e)
- f)
- 1)

(12.6)

(13.1.3)

- 2)

- g)
- h)

(10.5)
(9.3)

- 1)

—

—

125

- 2)
- 3)

—

—



3) 8.2.2 125 1 1) 2) 1

8.2.2 150
 i) 1) (9.9.1 9.9.2) () (9.9.3)

2) 9.9.11.1 9.9.11.2

j) (9.8) (F3)

1)

2) 125

8.2.2 1 1
 125

8.2.2¹ 150 125

()

k) () (9.8)

(F3)

()

()



1)

2)

()

L) (10.3 10.4)

1)

()

C5

C3

2)

(10.4.3.2)

8.2.2

1

1

m)

(14.2.3)

n)

(9.10)

o)

9.11

9.11

—
—

9.11.5

9.11.3



E

()

E1

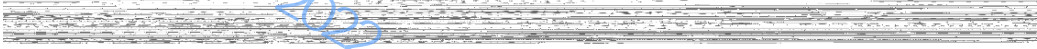

E2

16.2

16.2

a)

b)



F

()

F0
F0.1
F0.1.1

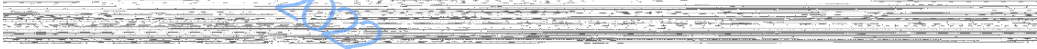

F0.1.2

F0.1.3
F0.1.4
F0.1.5

F0.1.6

a)
b)
c)
d)
e)
F0.2

±1

±2

±5

±5

0.01s

企业标准信息公共服务平台
2022 07 22 19 27



企业标准信息公共服务平台

2022 07 22 19 27

1.

2.

3.

4.

5.

6.

7.

8.

9.

10.

2022 07 22 19 27



F1
F1.1
F1.1.1

F1.1.2

F1.1.3

F1.1.3.1

a)

b)

c)

d) [()]

F1.1.3.2

F1.1.4

F1.2

F1.2.1

a)

7mm 7.7.3.1.1

b)

F1.2.2

7.7.5.1



b) 200V 2A

F1.2.4.2.1

5 10 s
50

0.5s

0.7±0.05

11

F1.2.4.2.2

110

5 10 s
20

0.5s

300ms
110

95

F1.2.4.2.3

F1.2.4.4

14.1.2.2.3

F1.2.4.5

14.1.2.2

F1.3

F1.3.1

7.7.6.1

7.7.6.2

F1.2

F1.3.2

F1.3.2.1

F1.2.2.2

F1.3.2.2

F1.4

F1.4.1



F1.4.2

a)F0.2

b)

c)

d)

企业标准信息
2022 07 22 19 27

F2

F3

F3.1

a)

b)

F3.2

F3.2.1

F3.2.2

F3.2.2.1

a)

b)

F3.2.2.2

a)

b)

c)



F3.2.3

F3.2.3.1

a)

b)

F3.2.3.2

a)

b)

1)

2)

F3.2.4

F3.2.4.1

9.9.1

$$h = \frac{v_1^2}{2g_n} + 0.10 + 0.03$$

h—

m

v_1 —

m/s

0.10—

m

0.03—

m

$$2K = (P+Q)_1 \times g_n \times h$$

$$(P+Q)_1 = \frac{2K}{g_n \times h}$$

$(P+Q)_1$ —

kg

P—

kg

Q—

kg

K—

J

F3.2.4.2

a)

K F3.2.3.2.a)

2

(kg)

$$(P+Q)_1 = \frac{K}{g_n \times h}$$



b)

1) K_1 F3.2.3.2b)1)

2

(kg)

$$(P+Q)_1 = \frac{K_1}{g_n \times h}$$

2) K_2 F3.2.3.2b)2)

3.5

(kg)

$$(P+Q)_1 = \frac{2K_2}{3.5 \times g_n \times h}$$

K_1 K_2 —

J

F3.2.5

F3.3

F3.3.1

F3.3.1.1

(kg)

(m/s)

(N)

16

(kg)

$0.6g_n$

F3.3.1.2

F3.3.2

F3.3.2.1

a)

b)

c)

d)

a) b)

1)

2)

3)

F3.3.2.2



F3.3.2.2.1

- a)
- b)

4m/s

4m/s

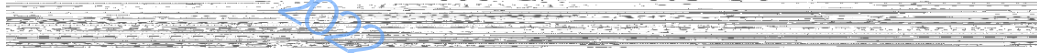

F3.3.2.2.2

- a)
- b)

()

F3.3.2.3

F3.3.2.3.1

25%

F3.3.2.3.2

()

F3.3.2.3.1

F3.3.2.4



a)

b)

)

c)

F3.3.3

F3.3.3.1

(P+Q)1= /16

—

F3.3.2.3

N

F3.3.3.2

F3.3.3.2.1

F3.3.3.1

F3.3.3.2.2

F3.3.3.1

F3.3.4

20

F3.3.3.1

F3.4

a)1)

2)

7.5

9.8.4

F3.3.3

±

b)

c)

(

)

d)

e)

F3.5

F3.5.1

F3.5.2



a)F0.2

b)

c)

[F3.4a)];

d)

e)

f)

g)

h)

i)

F4

F4.1

a)

b)

c)

F4.2

F4.2.1

a)

b)

c)

F4.2.2

F4.2.2.1

a)

b) 9.9.11.1

c) 9.9.11.2

d)

F4.2.2.2

[F4.1b)

]



1
 2
 3
 F4.2.2.3
 F4.2.2.3.1 20 9.9.1 20
 F4.2.2.3.2 20 F4.2.2.1b) c) 9.9.11.1
 9.9.11.2
 F4.2.2.3.3 300N

1 180
 2
 F4.3
 F4.3.1
 F4.3.2
 a)F0.2
 b)
 c)
 d)
 e)
 f)
 F5
 F5.1
 ()
 a)
 b)
 F5.2
 a)
 b)
 F5.3
 F5.3.1
 F5.3.1.1
 F5.3.1.1.1

企业标准
 2022 07 22 19 27

2022 07 22 19 27



a)
$$v \leq \sqrt{\frac{Fl}{0.135}} \quad (10.4.1.1.1)$$

1 m/s(10.3.3)

FL——

m

b)

1) Cr/2.5

2) Cr/4

Cr——

k8

F5.3.1.1.2 ()

F5.3.1.2

F5.3.1.2.1

()

()

FO.1.6

F5.3.1.2.2

F5.3.1.2.3 ()

F5.3.1.3 ()

F5.3.1.4

F5.3.1.5

F5.3.2

F5.3.2.1

F5.3.2.2

F5.3.2.2.1

FO.1.6

F5.3.2.2.2

FO.1.6

)

(
1 000 Hz

F5.3.2.2.3

FO.1.6

F5.3.2.2.4

() (5.3.2.1)

F0.1.6

F5.3.2.2.5

0.01 s

F0.1.6

F5.3.2.3

(15 25)

F0.1.6

F5.3.2.4

F5.3.2.5

F5.3.2.6

F5.3.2.6.1

10.4.3.3

F5.3.2.6.2



F5.3.2.7

F5.3.3

F5.3.3.1

F5.3.3.1.1

0.8m/s

F5.3.3.1.2

0.9 gn

F5.3.3.2

F5.3.2.2.2 F5.3.2.2.3 F5.3.2.2.4

F5.3.3.3

(15— 25)

F5.3.3.4

F5.3.3.5

a)

b)

(5 30)min

50

F5.3.3.6

F5.3.3.6.1

“ ”

a)

1.0gn

(n)

b) 2.5gn

0.04s

F5.3.3.6.2

F5.3.3.7

F5.4
F5.4.1

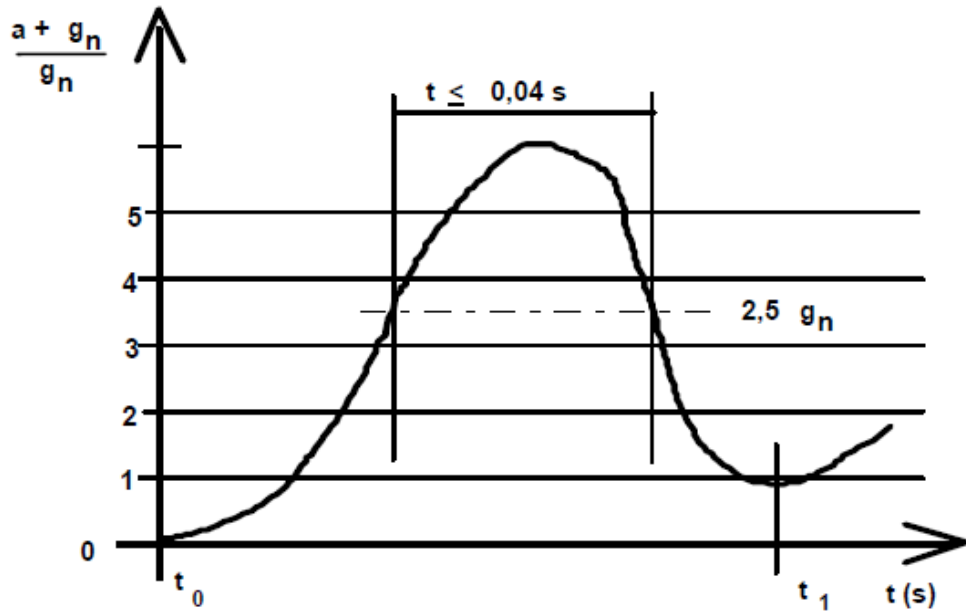

t_0 —撞击缓冲器瞬间(第1个绝对值最小时); t_1 —第2个绝对值最小时
图F1 减速图

F5.4.2
a)F0.2
b)
c)
d)
e)
f)
g) ()
F6

F6.1

a)
b)
c)
d)



f)
g)
F6.2

a)
b)
F6.3
F6.3.1

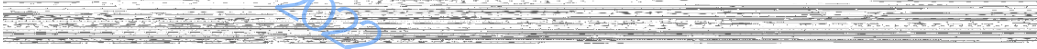

F6.3.1.1

a)GB/T 2423.10— 1995 C2
20

0.35mm 5gn 10 Hz 55

Hz

b)GB/T 2423.5— 1995 1
1) 294m/s² 30g
2) 11 ms
3) 2.1 m/s

F6.3.1.2 (GB/T 2423.6)

a)
b)

F6.3.1.2.1

a)
b) 15 g
c) 11 ms

F6.3.1.2.2

a) 10g
b) 16ms
c)1) 1 000+10
2) 2/s

F6.3.2 (GB/T 2423.22)



0'C 65'C()

a)

b)

c)

d)

e)

企业标准信息 (0 65) (4 h)

F6.4

F6.4.1

F6.4.2

a)F0.2

b)

c)GB/T 16935.1

d)

e)

F7

F3 F4 F6

F7.1

a)

b)

c)

a)

b)

c)

F7.2

F7.2.1

(kg)

(m/s)

F7.2.2



- a)
- b) F3 F4 F6

F7.3
F7.3.1

- a)
- b)
- c)

F7.3.2

20

F7.3.2.1

- a)
- b)

F7.3.2.2

)

F7.3.2.3
F7.3.2.3.1

F7.3.2.3.2

20
F7.3.3

- a)

企业标准信息公共服务平台
2022 07 22 19 27

F7.1b)

4 m/s
4m/s

()

()

20

9.10.1



b)

)

(

c)

d)

F7.4

1 zo

20

F7.5

a)

b)

c)

d)

e)

f)

g)

F7.6

F7.6.1

F7.6.2

a)F0.2

b)

c)

d)

e)

F8

F8.1

—

—

—

—

—

1



—
—

2

1

1.5 m/s²

2m/s

1.5 m/s²

2.5m/s²

2

a
b
c

F8.2
F8.2.1
F8.2.2

F8.3
F8.3.1

—
—
—
—
—
—

F2

企业标准信息
2022 07 22 19 27

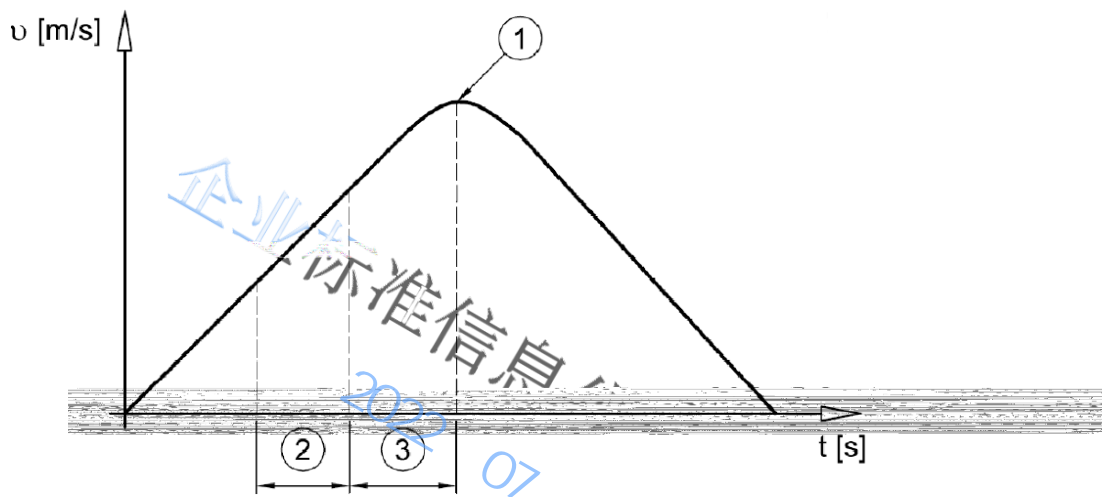

—
—
—

F2

F8.3.2

20

—
—

± 20 %

GB/T 24478-2009 4.2.2.4

F8.3.2.1

2022 07 22 19 27

10

10

5

F8.3.2.2

F8.3.2.3

10



F8.3.2.4
10

F8.3.3

a

b

c

F8.4

19 27
20 %

F8.5

—
—
—
—
—
—
—

F8.6

a F0.2

b

c

d

e

f

g)

/



G

()

G1

G1.1 10.1.1

G1.1.1

Q

G2.2

G1.1.2

G2

G2.1

()

P

G2.2

“

”

“

07

”

8.2

Q G7

3/4

(0.25)

G2.3

F_k

$$F_k = \frac{k_1 g_n (P + Q)}{n}$$

k₁——

G2

n——

G2.4

F_c

$$F_c = \frac{k_1 g_n (P + qQ)}{n} \quad \text{或} \quad F_c = \frac{k_1 g_n qP}{n}$$

q——

G2.5

F_s 0.4g_nQ

2 500k8

F_s 0.6g_nQ

2 500kg

F_s 0.85g_nQ

2 500kS



G2 6

G

a)

b)

c)

()

5

10

G2 7

M

G2 8

WL

(0.25)

G3

G3 1

G

表G1

工 况	载 荷 和 外 力	P	Q	G	F _s	F _k 或F _c	M	WL
-----	-----------	---	---	---	----------------	--------------------------------	---	----

G3 2

G4

G4 1

G4 2

(4

K2

(P+Q)

G4 3

G2 6

K3

1gn

G4 4

G2



表G2

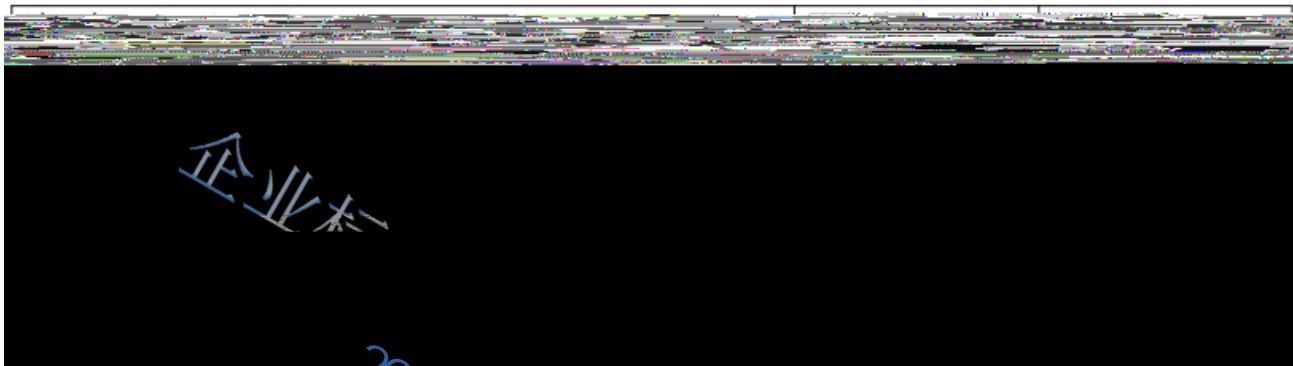

企业标准

2022 07 22 19 27

G5

G5.1

()

G5.2

G5.2.1

a)

b)

c)

G5.2.2

(G1)

a)

L

b)

c)

2022 07 22 19 27

m

M

3E.I

m—

N/mm²

M—

Nm

W—

mm³

Fb—

N

l—

mm

“

”

G5.2.3

W_x

W_y

(

)



G5.2.4

G5.2.5 9.8.2.2

G5.2.5.1

G5.2.5.2 G2.3

G2.4

G5.3

“ ”



k——	N/mm ²	MPa		
F _k ——			N	G2.3
F _c ——			N	G2.4
K ₃ ——	G2			
M——			N	
A——	mm ²			
	G3	370MPa	G4	520MPa

$$\lambda = \frac{l_k}{i} \quad \text{和} \quad l_k = l_2$$

l _k ——	mm		
i——	mm		
	R _m 370 MPa		
20	60	0.000 129 20×	1.89 +1
60<	85	0.000 046 27×	2.14 +1
85<	115	0.000 017 11×	2.35 +1.04
115<	250	0.000 168 87×	2.00



Rm 520MPa

20	50	0.000 082 40x	2.06 +1.021
50x	70	0.000 018 95x	2.41 +1.05
70x	89	0.000 024 47x	2.36 +1.03
89x	250	0.000 253 30x	2.00

370MPa 520MPa

$$\omega_R = \left[\frac{\omega_{520} - \omega_{370}}{520 - 370} \times (R_m - 370) \right] + \omega_{370}$$

表G3 19

λ	0	1	2	3	4	5	6	7	8	9	λ
20	1.04	1.04	1.04	1.05	1.05	1.06	1.06	1.07	1.07	1.08	20
30	1.08	1.09	1.09	1.10	1.10	1.11	1.11	1.12	1.12	1.12	20

2022 07 22 19 27



表G4

λ	0	1	2	3	4	5	6	7	8	9	λ
20	1.06	1.06	1.07	1.07	1.08	1.08	1.09	1.09	1.10	1.11	20
30	1.11	1.12	1.12	1.13	1.14	1.15	1.15	1.16	1.17	1.18	30
40	1.19	1.19	1.20	1.21	1.22	1.23	1.24	1.25	1.26	1.27	40

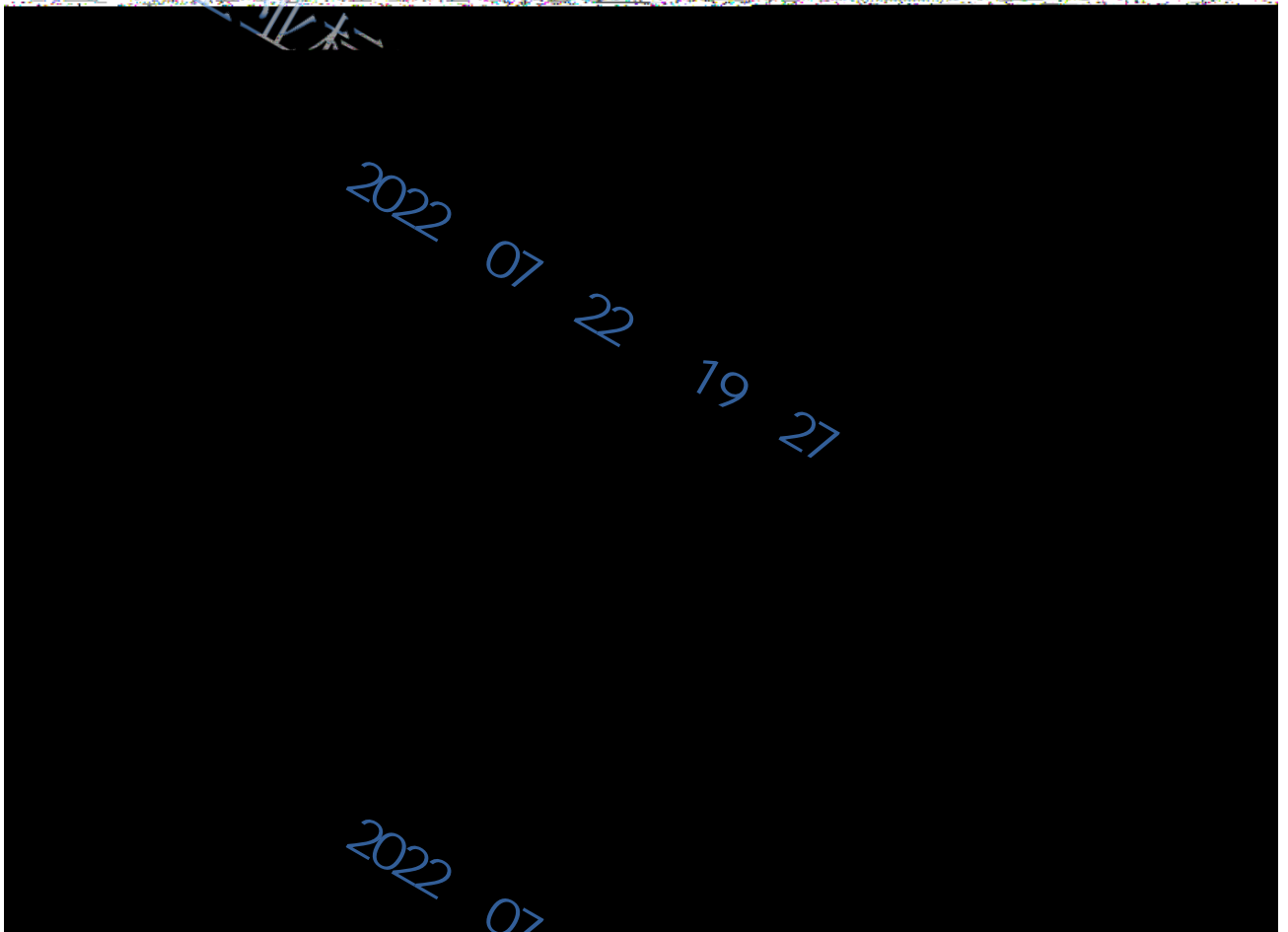

G5.4

m x+ y
perm

x —X
y—Y
perm—

Mpa
Mpa
Mpa 10 1. 2 1

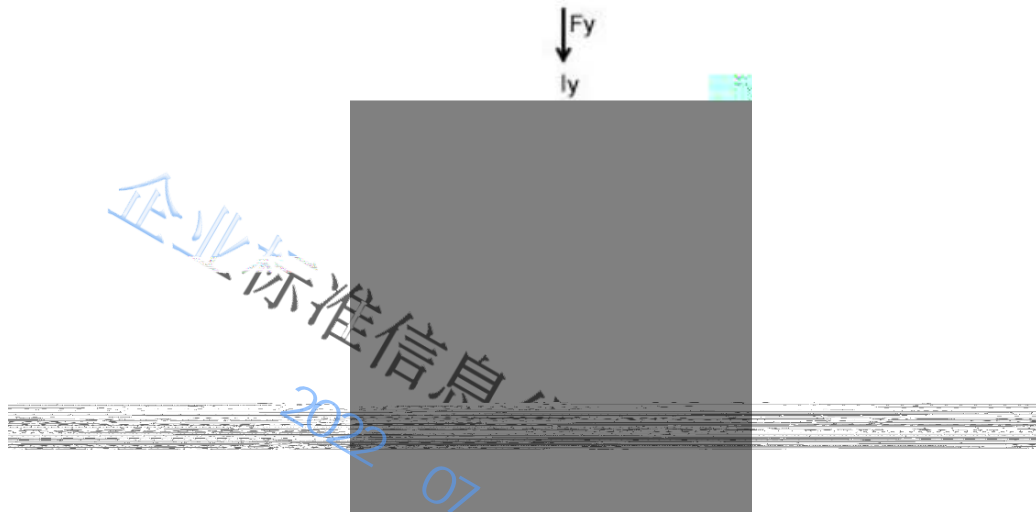

G5.5

T

F——

Mpa

Fx——

N

C——

mm

G1

G5.6

G7

G5.7

$$\delta_y = 0.7 \frac{F_y \cdot l^3}{48 \cdot E \cdot I_x} \quad \text{Y—Y导向面}$$

$$\delta_x = 0.7 \frac{F_x \cdot l^3}{48 \cdot E \cdot I_y} \quad \text{X—X导向面}$$

x——X

mm

y——Y

mm

Fx——X

N

Fy——Y

N

E ——

Mpa

I_x—— X

mm⁴

I_y

mm⁴

——Y

G6

T

10.1.2.2

10.1.1



1Q 1. 1

G7

()

(Q)

D_x —X

D_y —Y

x_c, y_c —

x_s, y_s —

x_p, y_p —

x_{cp}, y_{cp} —

S—

C—

P—

Q—

—

1, 2, 3, 4—

x_i, y_i —

n—

h—

x_Q, y_Q —

x_{cQ}, y_{cQ} —

C

S

P

P

—

—

—

—

—

—

—

—

—

Q

C

Q

X

Y

D_x

y

4

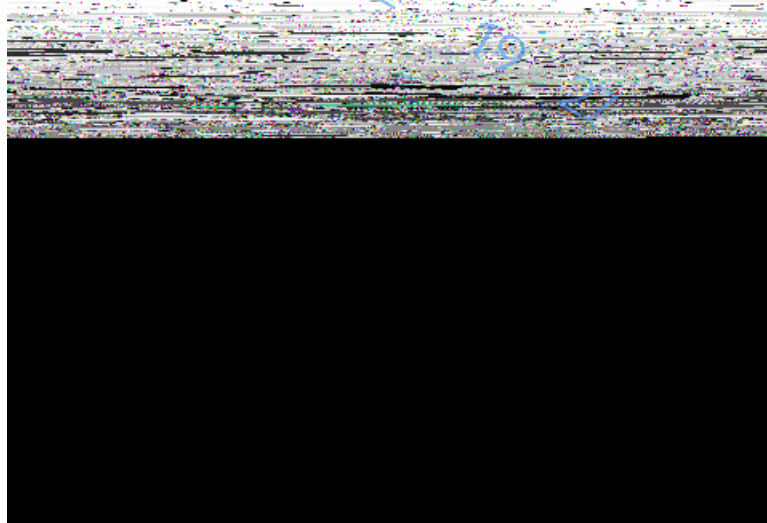

G7. 1
 G7. 1. 1
 G7. 1. 1. 1

a)

Y

$$F_x = \frac{k_1 \cdot g_n \cdot (Q \cdot x_Q + P \cdot x_P)}{n \cdot h}, \quad M_y = \frac{3 \cdot F_x \cdot l}{16}, \quad \sigma_y = \frac{M_y}{W_y}$$

b)

X

$$F_y = \frac{k_1 \cdot g_n \cdot (Q \cdot y_Q + P \cdot y_P)}{\frac{n \cdot h}{2}}, \quad M_x = \frac{3 \cdot F_y \cdot l}{16}, \quad \sigma_x = \frac{M_x}{W_x}$$

X (G3)

$$v = v + \frac{D_x}{l}$$

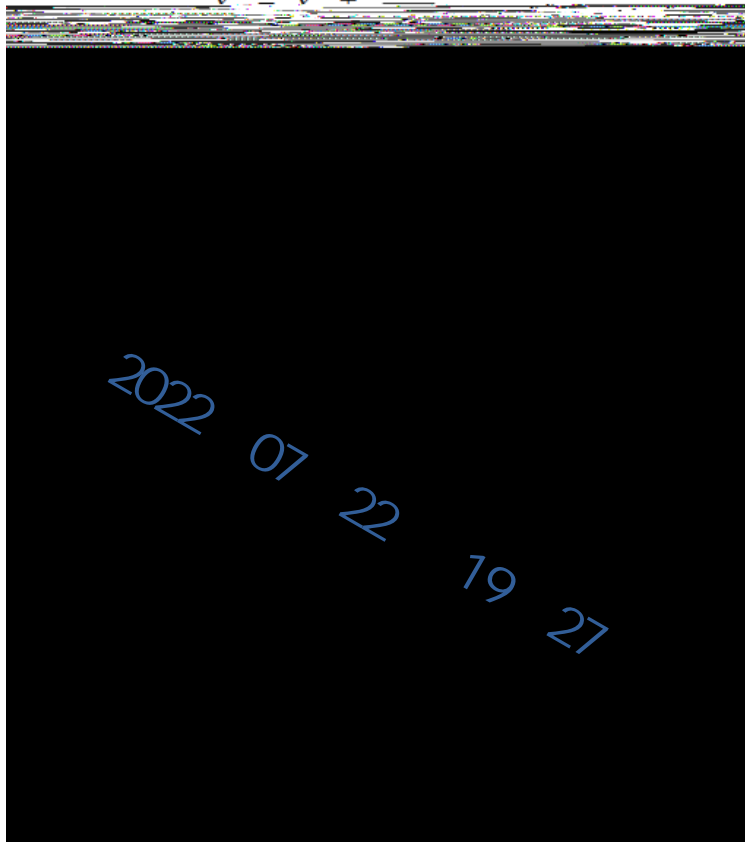

Y (G4)



$$x_Q = x_c$$

$$y_Q = y_c + \frac{D_y}{8}$$

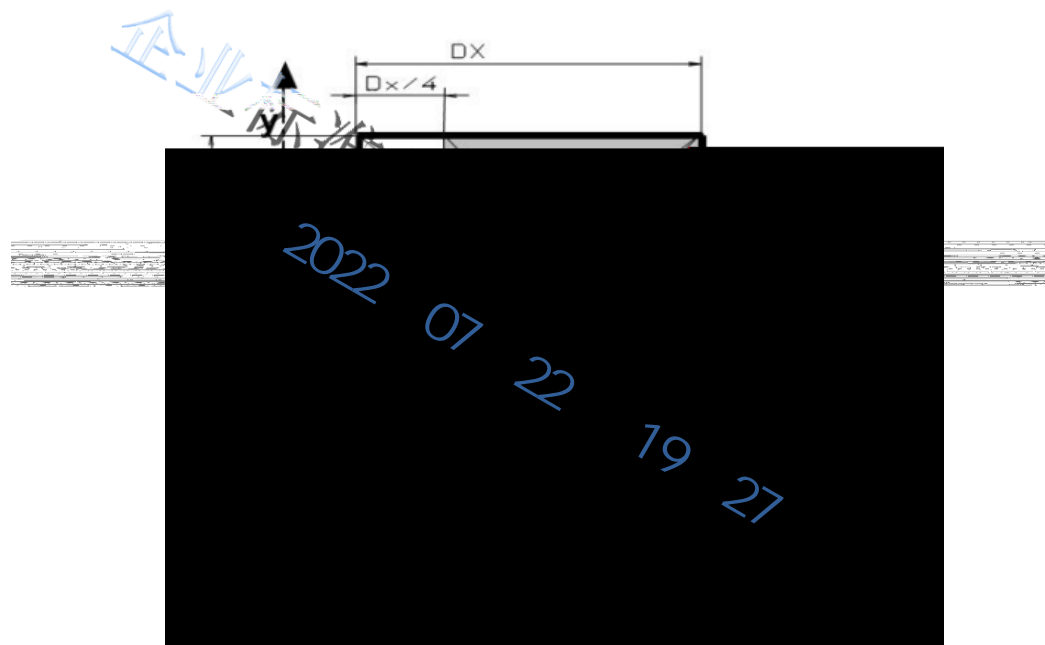

G7. 1. 1. 2

$$\sigma = \frac{k_1 \cdot g_n \cdot (P+Q)}{A} + \frac{(F_k + k_3 \cdot M) \cdot \omega}{I}$$

G7. 1. 1. 3

1)

$$\sigma = \sigma + \sigma < \sigma_{allow}$$

G7. 1. 1. 4

2)

$$\sigma = \frac{1,85 \cdot F_x}{A} < \sigma_{allow}$$

G7. 1. 1. 5

3)

$$\delta = 0,7 \cdot \frac{F_x \cdot l^3}{EI} < \delta_{allow} \quad \delta = 0,7 \cdot \frac{F_y \cdot l^3}{EI} < \delta_{allow}$$

G 1. 2

G7. 1. 2. 1

a)

Y



b) X

$$E = \frac{k_2 \cdot g_n \cdot [Q \cdot (y_Q - y_s) + P \cdot (y_p - y_s)]}{M} = \frac{3 \cdot F_y \cdot l}{M} \quad \sigma = \frac{M_x}{A}$$



X (G7. 1. 1. 1)

Y (G7. 1. 1. 1)

G7. 1. 2. 2

“ ”

G7. 1. 2. 3

4)

$$\sigma_m = \sigma_x + \sigma_y \leq \sigma_{perm}$$

$$\sigma = \sigma_m + \frac{k_3 \cdot M}{A} \leq \sigma_{perm}$$

G7. 1. 2. 4

5)



G7. 1. 2. 5

6)



G7. 1. 3

(G5)

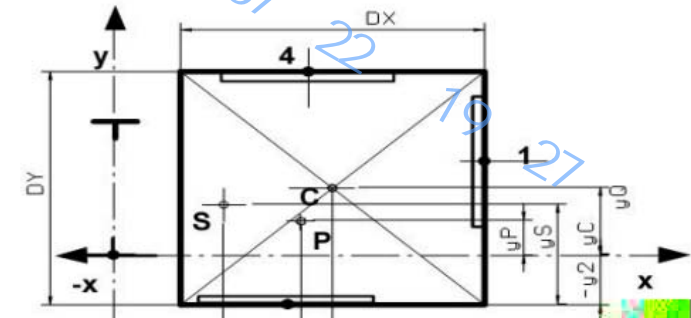

G7. 1. 3 1

a) Y

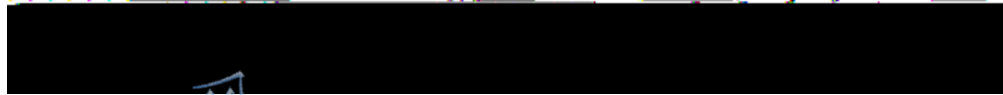

b) X

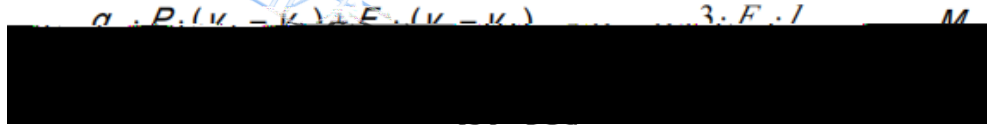

G7. 1. 3 2



G7. 1. 3 3

7(

$$\sigma_m = \sigma_x + \sigma_y \leq \sigma_{perm}$$



G7. 1. 3 4

$$\sigma_F = \frac{185 \cdot F_x}{c^2} \leq \sigma_{perm}$$

G7. 1. 3 5

$$\delta_x = 0,7 \frac{F_x \cdot l^3}{48 \cdot E \cdot I_y} \leq \delta_{perm} \quad \delta_y = 0,7 \frac{F_y \cdot l^3}{48 \cdot E \cdot I_x} \leq \delta_{perm}$$

G7. 2

G7. 2 1

G7. 2 1. 1

a) Y



b) X

$$F_y = \frac{k_1 \cdot g_n \cdot (Q \cdot y_Q + P \cdot y_P)}{\frac{n}{2} \cdot h}, \quad M_x = \frac{3 \cdot F_y \cdot l}{16}, \quad \sigma_x = \frac{M_x}{W_x}$$

X (G6)

P Q

Q X



$$x_Q = \frac{D_x}{8}$$

$$y_Q = 0$$



图 G6
Y (7)
 $x_n = 0$



G7.2 1.2

$$F_k = \frac{k_1 \cdot g_n \cdot (P + Q)}{2}, \sigma_k = \frac{(F_k + k_3 \cdot M)}{A} \cdot \omega$$

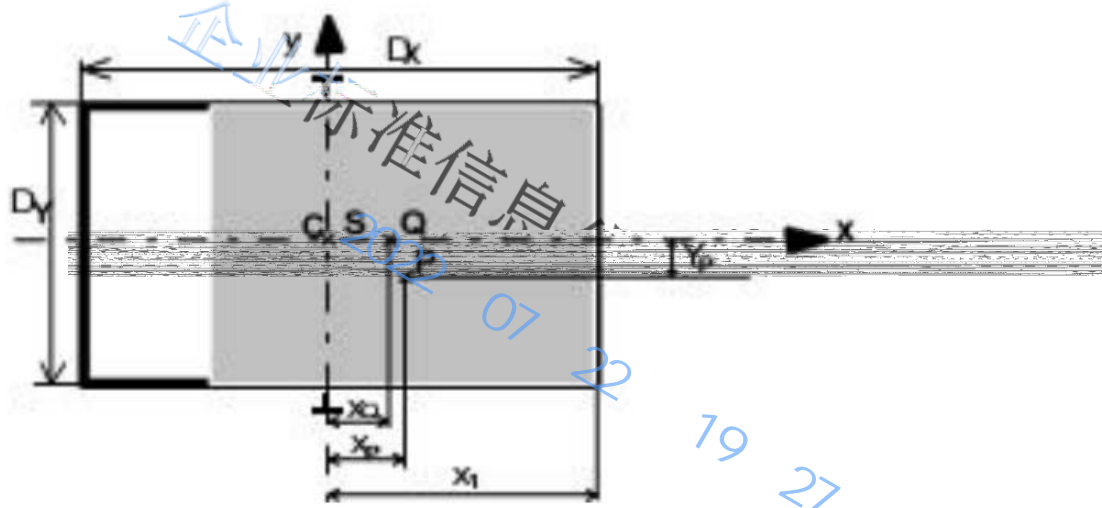
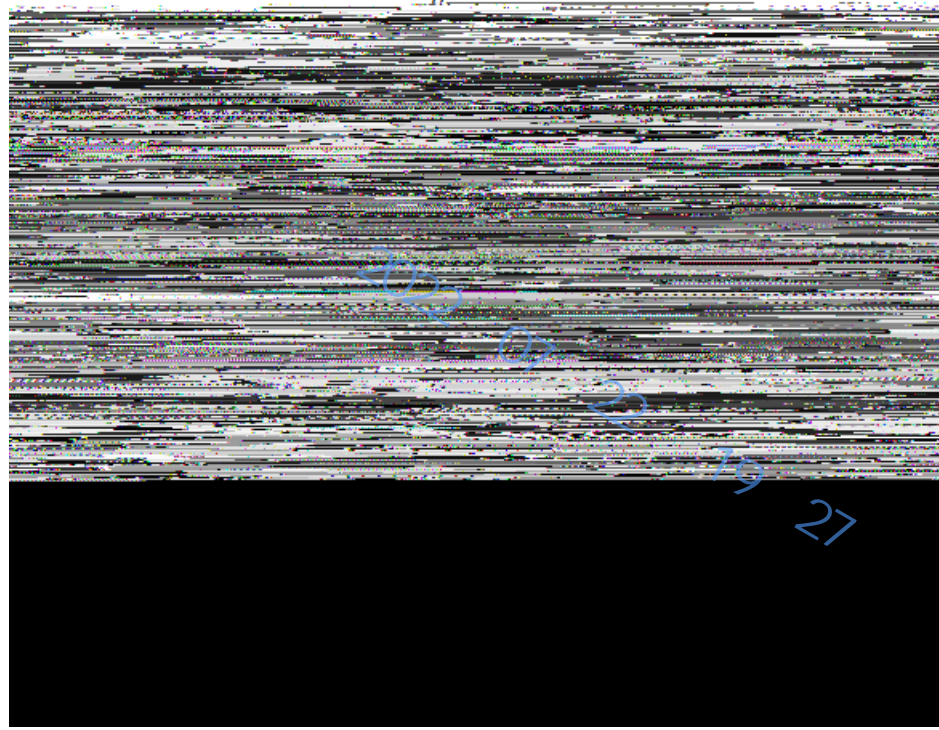
G7.2 1.3 8)



$$\sigma_m = \sigma_x + \sigma_y \leq \sigma_{perm}$$

$$\sigma = \sigma_m + \frac{F_k + k_3 \cdot M}{A} \leq \sigma_{perm}$$

$$\sigma_k = \sigma_k + 0,9 \cdot \sigma_m \leq \sigma_{perm}$$

G7.2.1.4

9)



G7.2.1.5

10)

$$\delta_x = 0,7 \frac{F_x \cdot l^3}{EI} \leq \delta_{perm} \quad \delta_y = 0,7 \frac{F_y \cdot l^3}{EI} \leq \delta_{perm}$$

G7.2.2

G7.2.2.1

a)

Y

$$M_y = \frac{k_2 \cdot g_n \cdot (Q \cdot x_Q + P \cdot x_P)}{2} = \frac{3 \cdot F_y \cdot l}{16} = M_y$$

b)

X

$$F_y = \frac{k_2 \cdot g_n \cdot (Q \cdot y_Q + P \cdot y_P)}{\frac{n \cdot h}{2}}, \quad M_x = \frac{3 \cdot F_y \cdot l}{16}, \quad \sigma_x = \frac{M_x}{W_x}$$

X (G7.2.1.1)

Y (G7.2.1.1)

G7.2.2.2

"

"

G7.2.2.3

11)

$$\sigma_m = \sigma_x + \sigma_y \leq \sigma_{perm}$$

$$\sigma = \sigma_m + \frac{k_3 \cdot M}{A} \leq \sigma_{perm}$$

G7.2.2.4

12)

$$\sigma_F = \frac{1,85 \cdot F_x}{c^2} \leq \sigma_{perm}$$



G7.2.2.5 13)

$$\delta_x = 0,7 \frac{F_x \cdot l^3}{48 \cdot E \cdot I_y} \leq \delta_{perm} \quad \delta_y = 0,7 \frac{F_y \cdot l^3}{48 \cdot E \cdot I_x} \leq \delta_{perm}$$

G7.2.3

G7.2.3.1

a)

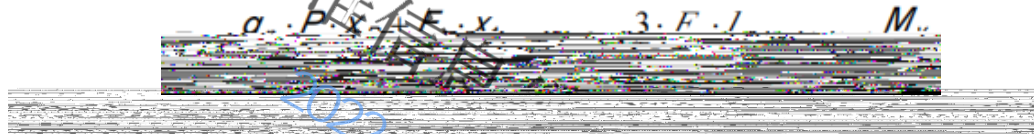

b)

$$F_y = \frac{g_n \cdot P \cdot y_P + F_s \cdot y_1}{h}, \quad M_x = \frac{3 \cdot F_y \cdot l}{16}, \quad \sigma_x = \frac{M_x}{W_x}$$

G7.2.3.2

“

”

G7.2.3.3

14)

$$\sigma_m = \sigma_x + \sigma_y \leq \sigma_{perm}$$

$$\sigma = \sigma_m + \frac{k_3 \cdot M}{A} \leq \sigma_{perm}$$

G7.2.3.4

$$\sigma_F = \frac{185 \cdot F_x}{c^2} \leq \sigma_{perm}$$

G7.2.3.5

$$\delta_x = 0,7 \frac{F_x \cdot l^3}{48 \cdot E \cdot I_y} \leq \delta_{perm} \quad \delta_y = 0,7 \frac{F_y \cdot l^3}{48 \cdot E \cdot I_x} \leq \delta_{perm}$$

G7.3

G7.3.1

G7.3.1.1

a)

Y

$$F = \frac{k_1 \cdot g_n \cdot (Q \cdot x_Q + P \cdot x_P)}{h}, \quad M = \frac{3 \cdot F_x \cdot l}{16}, \quad \sigma = \frac{M_y}{W_y}$$

b)

X

$$F = \frac{k_1 \cdot g_n \cdot (Q \cdot y_Q + P \cdot y_P)}{h}, \quad M = \frac{3 \cdot F_y \cdot l}{16}, \quad \sigma = \frac{M_x}{W_x}$$

X (G8)



$$x_Q = x_C + \frac{D_x}{8}$$
$$y_P = y_C = y_Q = y_S = 0$$

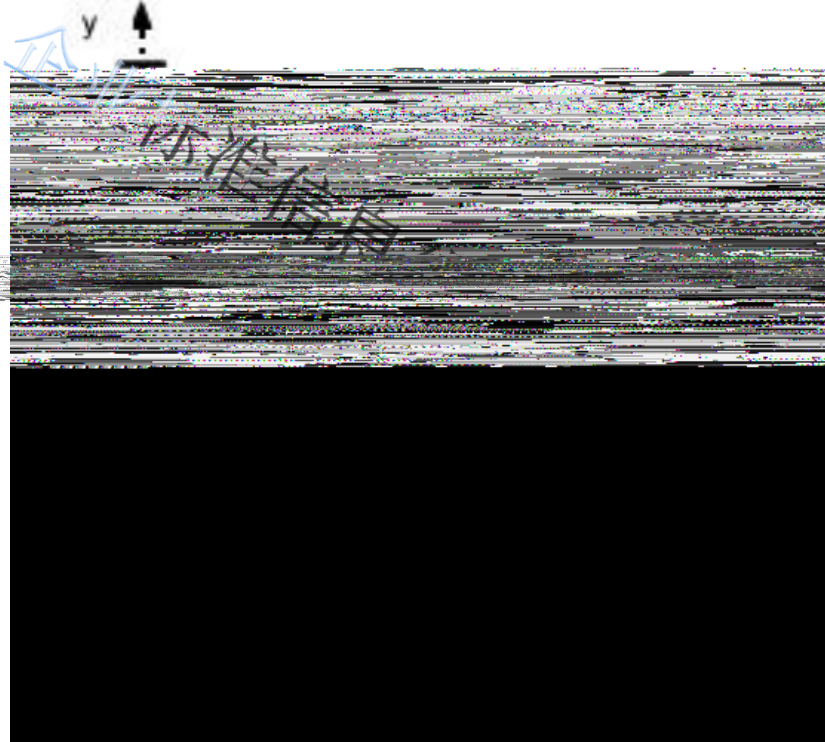

Y (G)

$$y_Q = \frac{D_y}{8}$$
$$x_C = x_Q$$

G7.3 1.2

$$k \cdot g_n \cdot (P + Q) \quad (F + k \cdot M \cdot \varphi)$$

G7.3 1.3

15)

$$\sigma_x + \sigma_y \leq \sigma_{perm}$$

$$\sigma = \sigma_m + \frac{k_3 \cdot M}{A} \leq \sigma_{perm}$$

$$\sigma_c = \sigma_k + 0,9 \cdot \sigma_m \leq \sigma_{perm}$$

G7.3 1.4

16)

$$185 \cdot F$$

G7.3 1.5

17)

$$\delta_x = 0,7 \frac{F_x \cdot l^3}{48 \cdot E \cdot I_y} \leq \delta_{perm}, \quad \delta_y = 0,7 \frac{F_y \cdot l^3}{48 \cdot E \cdot I_x} \leq \delta_{perm}$$

G7.3 2

G7.3 2.1

a)

Y

$$F_x = \frac{k_2 \cdot g_n \cdot [Q \cdot (x_Q - x_S) + P \cdot (x_P - x_S)]}{n \cdot h}, \quad M_y = \frac{3 \cdot F_x \cdot l}{16}, \quad \sigma_y = \frac{M_y}{W_y}$$

b)

X

$$k_2 \cdot g_n \cdot [Q \cdot (v_Q - v_S) + P \cdot (v_P - v_S)] \quad 3 \cdot F_x \cdot l \quad M$$

X (G7.2 1.1)

Y (G7.2 1.1)

G7.3 2.2

“ ”

G7.3 2.3

18)

$$\sigma_m = \sigma_x + \sigma_y \leq \sigma_{perm}$$

$$\sigma = \sigma_m + \frac{k_3 \cdot M}{A} \leq \sigma_{perm}$$

G7.3.2.4 19)

$$\sigma_F = \frac{1,85 \cdot F_x}{c^2} \leq \sigma_{perm}$$

G7.3.2.5 20)



G7.3.3 (G10)



图 G10

G7.3.3.1

a) Y

$$\sigma = \frac{P \cdot (x_c - x_s) + F \cdot (x_c - x_l)}{A} \leq \sigma_{perm}$$

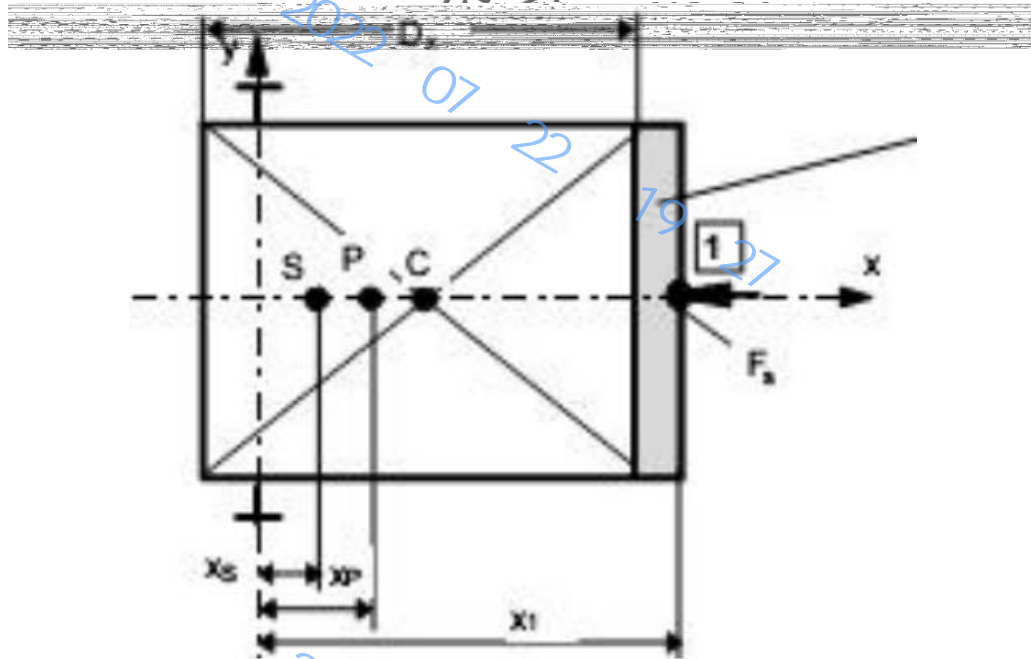
b) X

$$F_y = 0$$

G7.3.3.2

“ ”

G7.3.3.3 21)

$$\sigma_m = \sigma_y \leq \sigma_{perm}$$

$$\sigma = \sigma_m + \frac{k_3 \cdot M}{A} \leq \sigma_{perm}$$

G7.3.3.4

$$\sigma_F = \frac{1,85 \cdot F_x}{c^2} \leq \sigma_{perm}$$

G7.3.3.5

$$\delta_x = 0,7 \frac{F_x \cdot l^3}{48 \cdot E \cdot I_y} \leq \delta_{perm} \quad \delta_y = 0$$

G7.4



Y (G12)

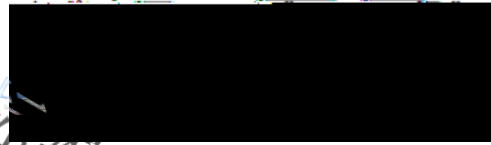

企业标准信息公共服务平台

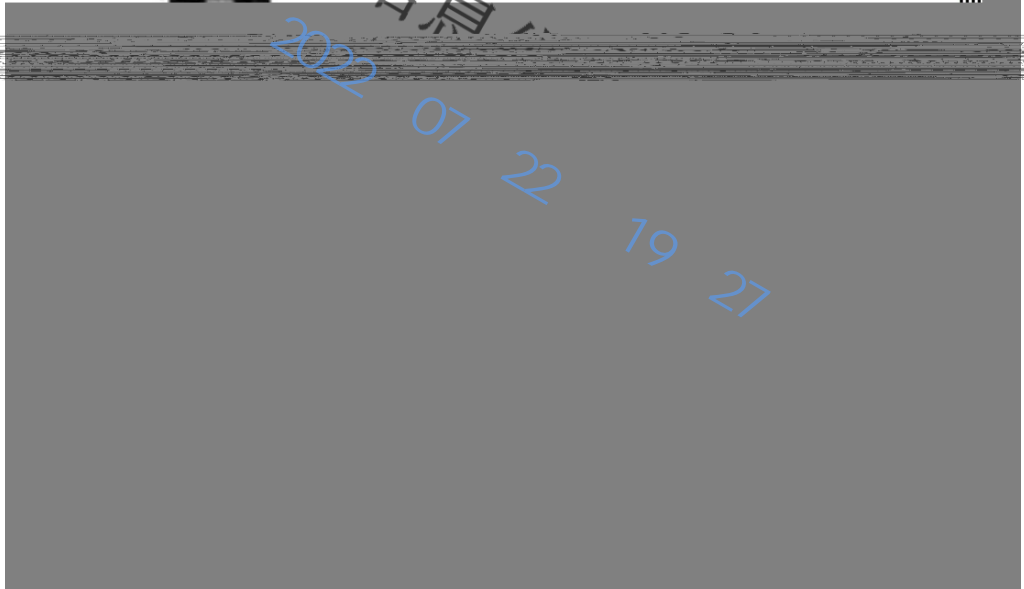

G7.4.1.2

$$F_k = \frac{k_1 \cdot g_n \cdot (P+Q)}{n}, \sigma_k = \frac{(F_k + k_3 \cdot M) \cdot \omega}{A}$$

G7.4.1.3

22)

$$\sigma_m = \sigma_v + \sigma_v \leq \sigma_{norm}$$



G7.4.1.4

23)



G7.4.1.5 24)

$$\delta_x = 0,7 \frac{F_x \cdot l^3}{E \cdot I_y} \leq \delta_{perm}, \delta_y = 0,7 \frac{F_y \cdot l^3}{E \cdot I_x} \leq \delta_{perm}$$

G7.4.2

G7.4.2.1

a)

$$k \cdot \sigma \cdot [Q \cdot (v_0 - v_1) + P \cdot (v_0 - v_1)] \leq \frac{3 \cdot F \cdot l}{M}$$

b)

$$k \cdot \sigma \cdot [Q \cdot (v_0 - v_1) + P \cdot (v_0 - v_1)] \leq \frac{3 \cdot F \cdot l}{M}$$

X (G7.4.1.1)

Y (G7.4.1.1)

G7.4.2.2

“ ”

G7.4.2.3

25)

$$\sigma_m = \sigma_x + \sigma_y \leq \sigma_{perm}$$

$k \cdot M$

G7.4.2.4

26)

$$\sigma_F = \frac{1,85 \cdot F_x}{C^2} \leq \sigma_{perm}$$

G7.4.2.5

27)

$$\delta_x = 0,7 \frac{F_x \cdot l^3}{48 \cdot E \cdot I_y} \leq \delta_{perm}, \delta_y = 0,7 \frac{F_y \cdot l^3}{48 \cdot E \cdot I_x} \leq \delta_{perm}$$

G7.4.3



$$x_p > 0 \quad y_p = 0$$

$$x_1 > 0 \quad y_1 = \frac{D_y}{2}$$

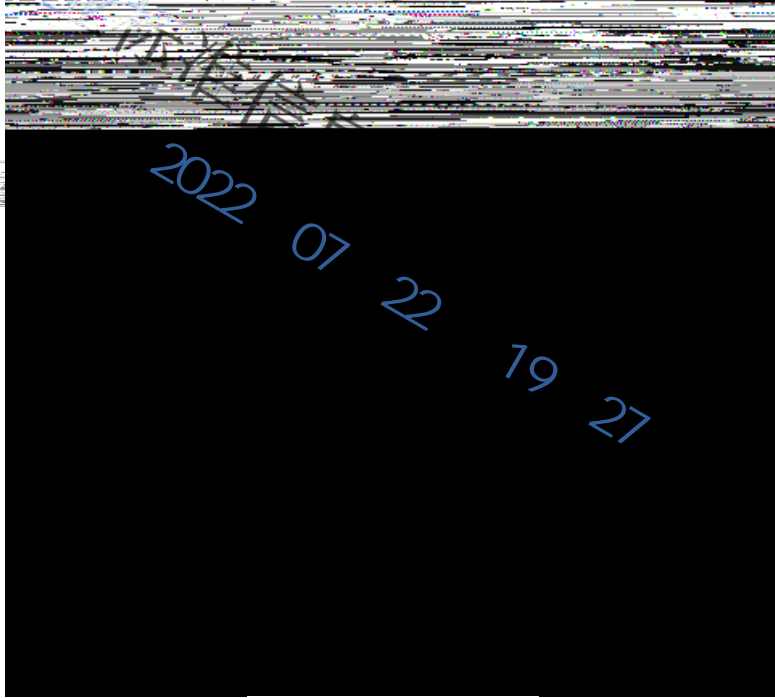

$$x_p > 0 \quad y_p = 0$$

$$x_2 > c + D_x \quad y_2 > 0$$

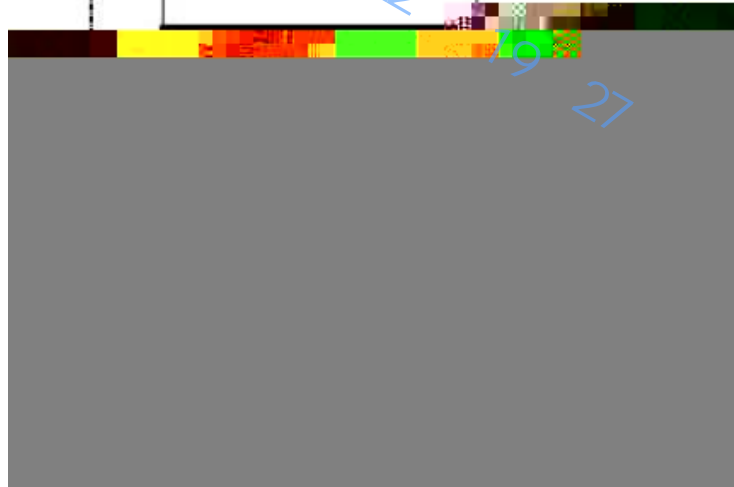
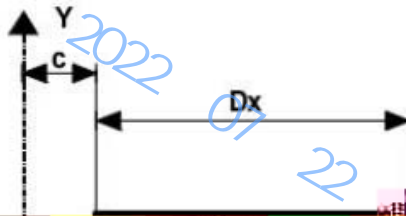

G7.4.3.1

a)

Y

$$F_x = \frac{g_n \cdot P \cdot x_p + F_s \cdot x_i}{n \cdot h}, \quad M_y = \frac{3 \cdot F_x \cdot l}{16}, \quad \sigma_y = \frac{M_y}{W_y}$$

b)

X

$$F_y = \frac{g_n \cdot P \cdot y_p + F_s \cdot y_i}{\frac{n}{2} \cdot h}, \quad M_x = \frac{3 \cdot F_y \cdot l}{16}, \quad \sigma_x = \frac{M_x}{W_x}$$

G7.4.3.2

“ ”

G7.4.3.3

$$\sigma_m = \sigma_x + \sigma_y \leq \sigma_{perm}$$

$$\sigma = \sigma_m + \frac{k_3 \cdot M}{A} \leq \sigma_{perm}$$

G7.4.3.4

$$\sigma_F = \frac{185 \cdot F_x}{c^2} \leq \sigma_{perm}$$

G7.4.3.5

$$\delta_x = 0,7 \frac{F_x \cdot l^3}{48 \cdot E \cdot I_x} \leq \delta_{perm} \quad \delta_y = 0,7 \frac{F_y \cdot l^3}{48 \cdot E \cdot I_x} \leq \delta_{perm}$$

G7.5

G7.5.1

G7.5.1.1

a)

Y

$$k_1 \cdot g_n \cdot (Q \cdot x_Q + P \cdot x_P) \quad 3 \cdot F_y \cdot l \quad M_y$$

b)

X

$$F_y = \frac{k_1 \cdot g_n \cdot (Q \cdot y_Q + P \cdot y_P)}{\frac{n}{2} \cdot h}, \quad M_x = \frac{3 \cdot F_y \cdot l}{16}, \quad \sigma_x = \frac{M_x}{W_x}$$

X (G15)

xQ

3/4

yQ 0

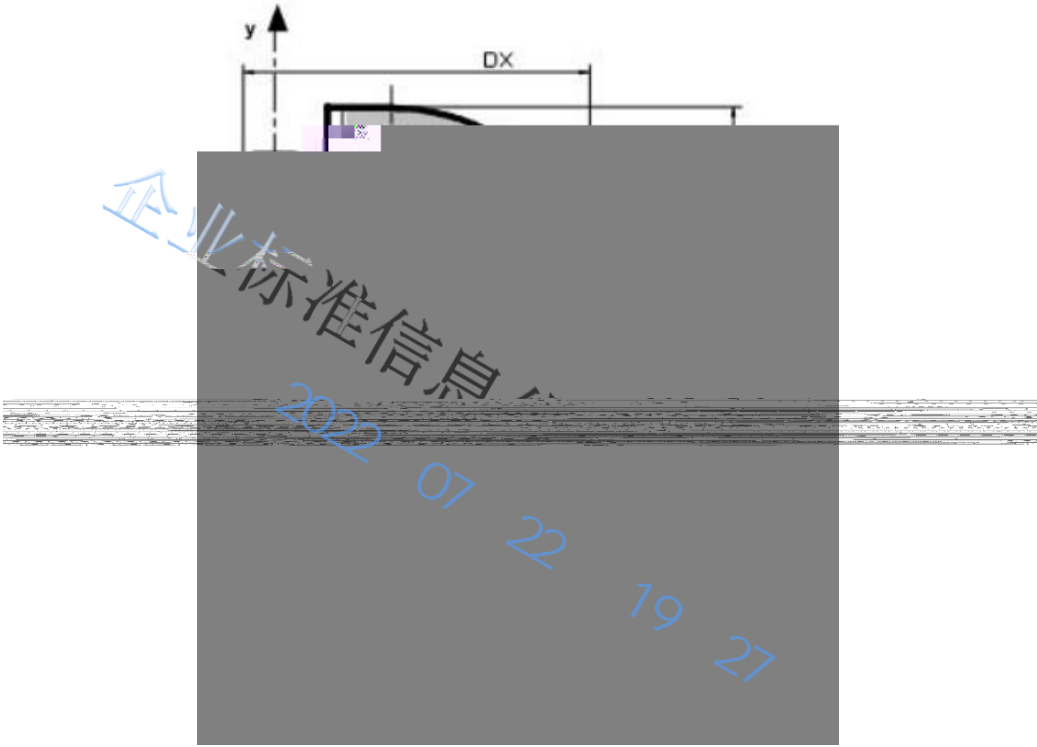

Y (G16)
3/4
xQ yQ



图 G16

G7. 5. 1. 2

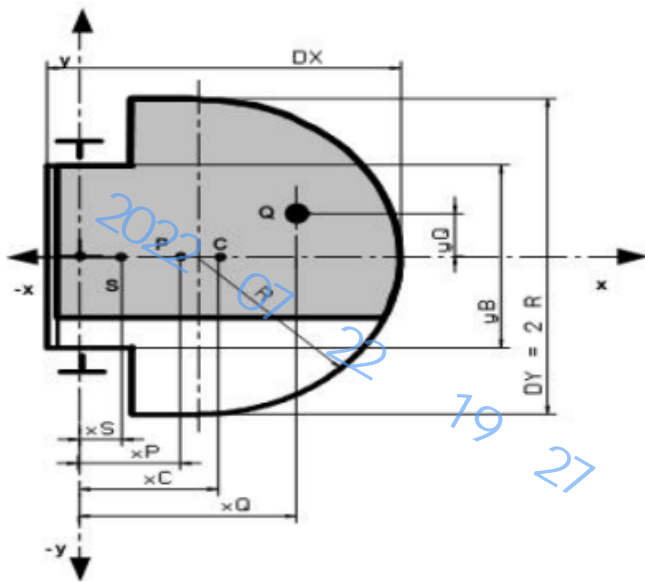

G7. 5. 1. 3

29)

$$\sigma_m = \sigma_x + \sigma_y \leq \sigma_{perm}$$



$$\sigma = \sigma_m + \frac{F_k + k_3 \cdot M}{A} \leq \sigma_{perm}$$

$$\sigma_c = \sigma_k + 0,9 \cdot \sigma_m \leq \sigma_{perm}$$

G7.5.1.4 30)

$$\frac{185 \cdot F_x}{c^2} \leq \sigma_{perm}$$

G7.5.1.5 31)

$$\delta_x = 0,7 \frac{F_x \cdot \dot{P}}{48 \cdot E \cdot I_y} \leq \delta_{perm} \quad \delta_y = 0,7 \frac{F_y \cdot \dot{P}}{48 \cdot E \cdot I_x} \leq \delta_{perm}$$

G7.5.2

G7.5.2.1

a) Y



b) X

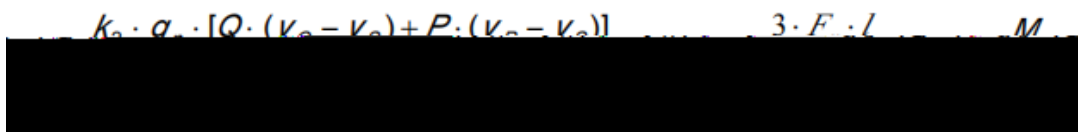

X (G7.5.1.1)

Y (G7.5.1.1)

G7.5.2.2

“ ”

G7.5.2.3 32)

$$\sigma_m = \sigma_x + \sigma_y \leq \sigma_{perm}$$

$$k_3 \cdot M$$

G7.5.2.4 33)

$$\sigma_F = \frac{185 \cdot F_x}{c^2} \leq \sigma_{perm}$$

G7.5.2.5 34)

$$\delta_x = 0,7 \frac{F_x \cdot \dot{P}}{48 \cdot E \cdot I_y} \leq \delta_{perm} \quad \delta_y = 0,7 \frac{F_y \cdot \dot{P}}{48 \cdot E \cdot I_x} \leq \delta_{perm}$$

G7.5.3

(G17)

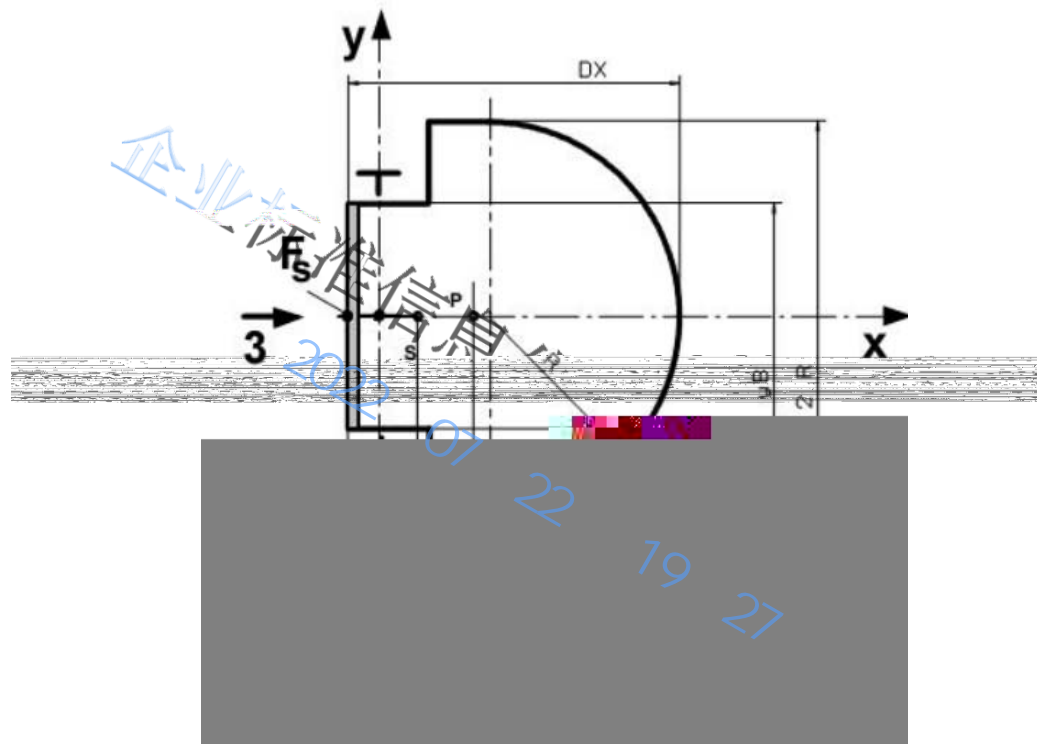

G7.5.3.1

a)

Y

$$F_x = \frac{q_n \cdot P \cdot (x_P - x_S) - F_s \cdot (x_i + x_S)}{n \cdot h}, \quad M_y = \frac{3 \cdot F_x \cdot l}{16}, \quad \sigma_y = \frac{M_y}{W_y}$$

b)

X

$$F_y = 0$$

G7.5.3.2

“

”

G7.5.3.3

$$\sigma_m = \sigma_y \leq \sigma_{perm}$$

$$k_3 \cdot M$$

G7.5.3.4

35)

$$\sigma_F = \frac{185 \cdot F_x}{c^2} \leq \sigma_{perm}$$

G7.5.3.5

$$\delta_x = 0,7 \frac{F_x \cdot l^3}{48 \cdot E \cdot I_y} \leq \delta_{perm}, \quad \delta_y = 0$$



H
()

14 1. 1. 1

14 1. 1. 1

企业标准信息

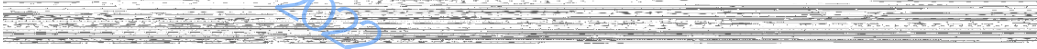

Hl 14 1. 1. 1e)
“ ”

()

Hl 3 1 3 6

14 1. 2 4

GB/T 16856

14 1. 2 3

GB 16895. 3

()



HI

元 件	可排除故障					条 件	备 注
	断 路	短 路	改 为 更 高 值	改 为 更 低 值	改 变 功 能		
1 无源元件							
1.1 定值电阻	否	(a)		(a)		(a)对根据国家标准进行轴向连接,且由涂漆或封闭处理的电阻膜制成的薄膜电阻器和由漆包线封闭保护的单层绕制的线绕电阻器	
1.2 可变电阻							



2.5 混合电路	否	否	否	否	否		
2.6 集成电路	否	否	否	否	否		功能改变成振荡,与门变成或门等
3 其他元件							

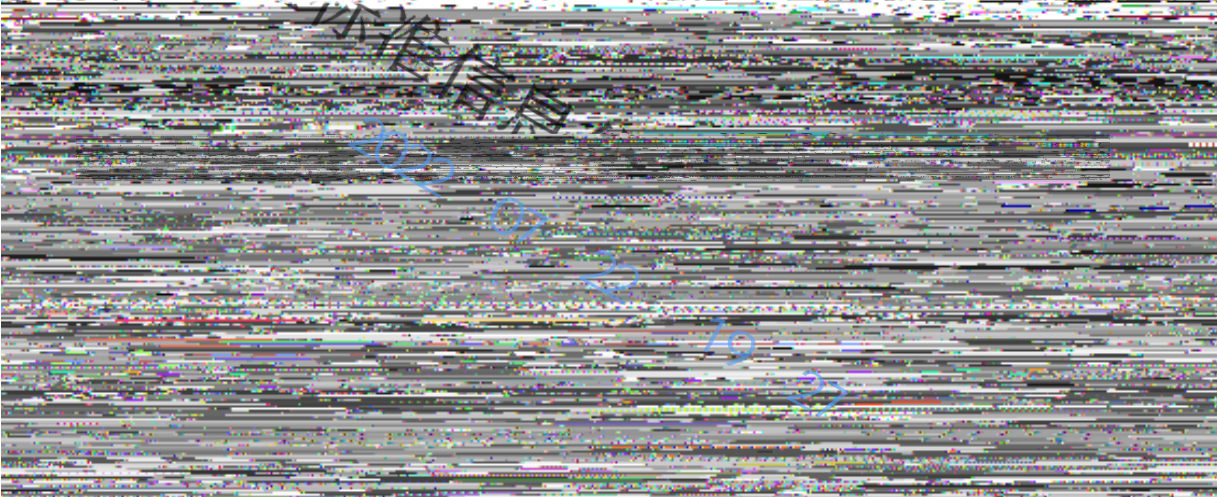

							短路包括初级
--	--	--	--	--	--	--	--------

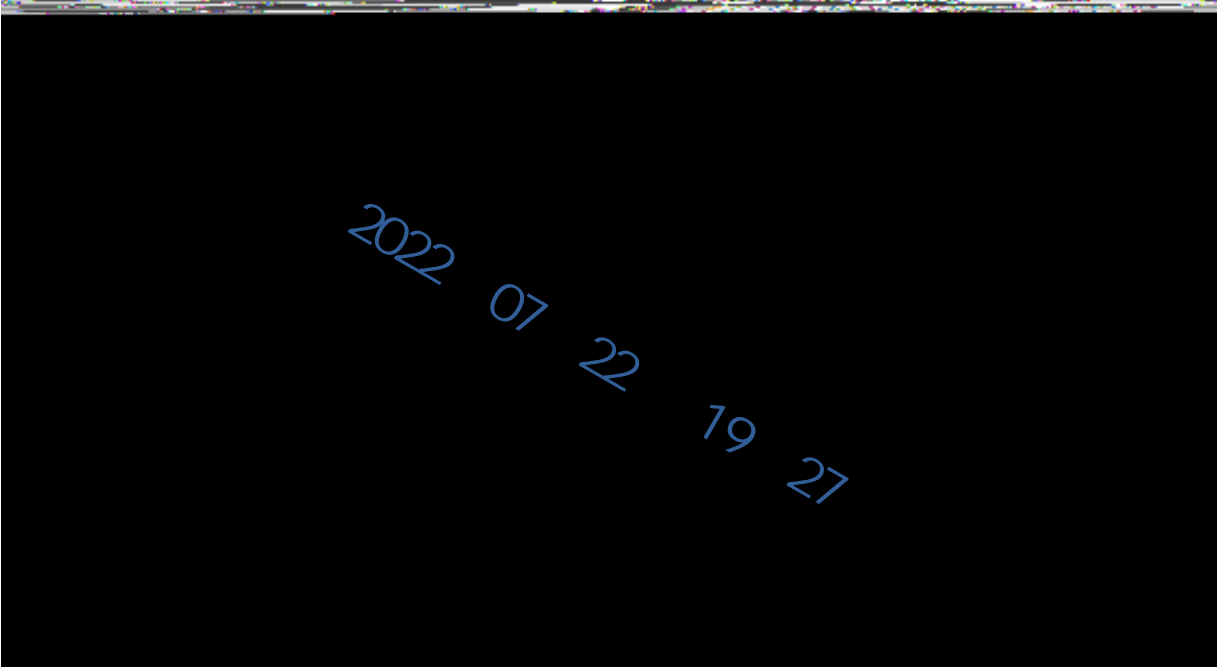

2022 07 22 19 27



					(a)短路排除的条件： -- PCB总体技术条件符合GB/T 16261的要求；
--	--	--	--	--	--

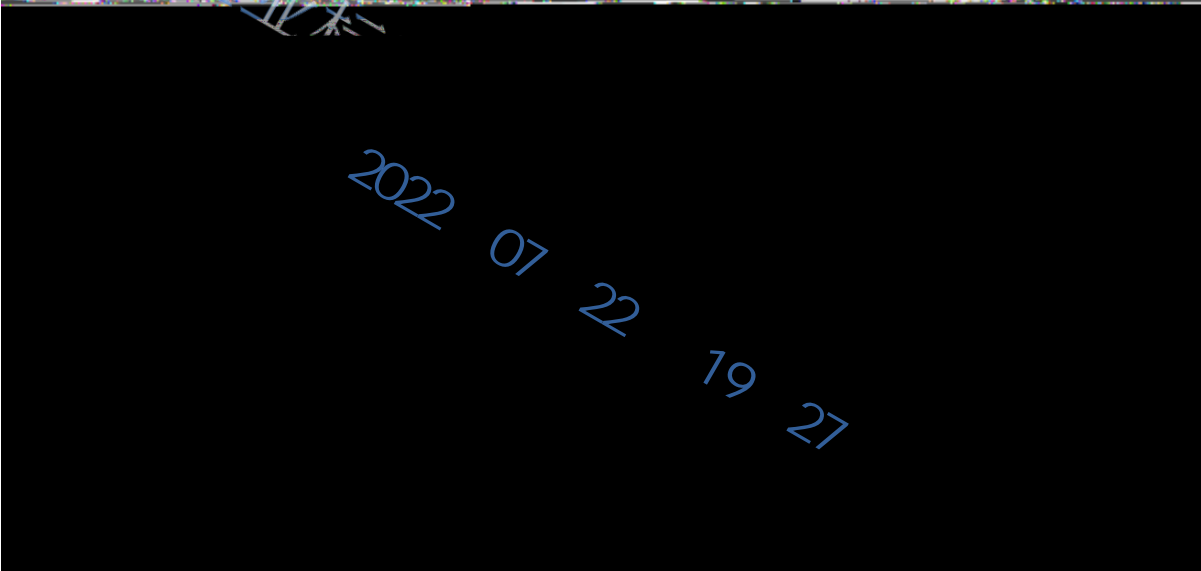

					(a)短路故障可以排除的条件是元件
--	--	--	--	--	-------------------





J
()

J1

7.2 3 1 8 3 2 1

8 6 7.1

J2

J2 1

J1 GB/T 700 Q235A

GB/T 700
(10±

Q275

(3.5± 0.25) mm

0.01) kg

J2 2

J2

(3.5

± 1) mm

(45± 0.5) kg

J2 3

3mm

15mm

()

1.5m

J2 4

J4 2 J4 3

J3

()
()

J4



J4 1 (23± 2)

4h

J4 2

J2 1

500nm(J3)

J4 3

J2 2

a)

800 nm J3

b)

700 nm J3

J4 4

1. 0± 0.1 m

7.2.3.8

J3

J4 5 J2 1 J2 2

J5

J5 1

a)

b)

c)

d)

e)

f)

2mm

J5 2

a)

b)

c)

J6

a)

b)

c)

d)

e)

f)

g)



J7

J1

J2

J1

	1m	2m
	nm	nm
	8	10
	4+Q 76+4	5+Q 76+5
	10	12
	5+Q 76+5	6+Q 76+6

J2

	nm	nm	m	
	16	360-720	2 1	
	8+Q 76+8			
	16	300-720	2 1	
	8+Q 76+8			
	10	300-870	2 1	
	6+Q 76+4			
	5+Q 76+5			

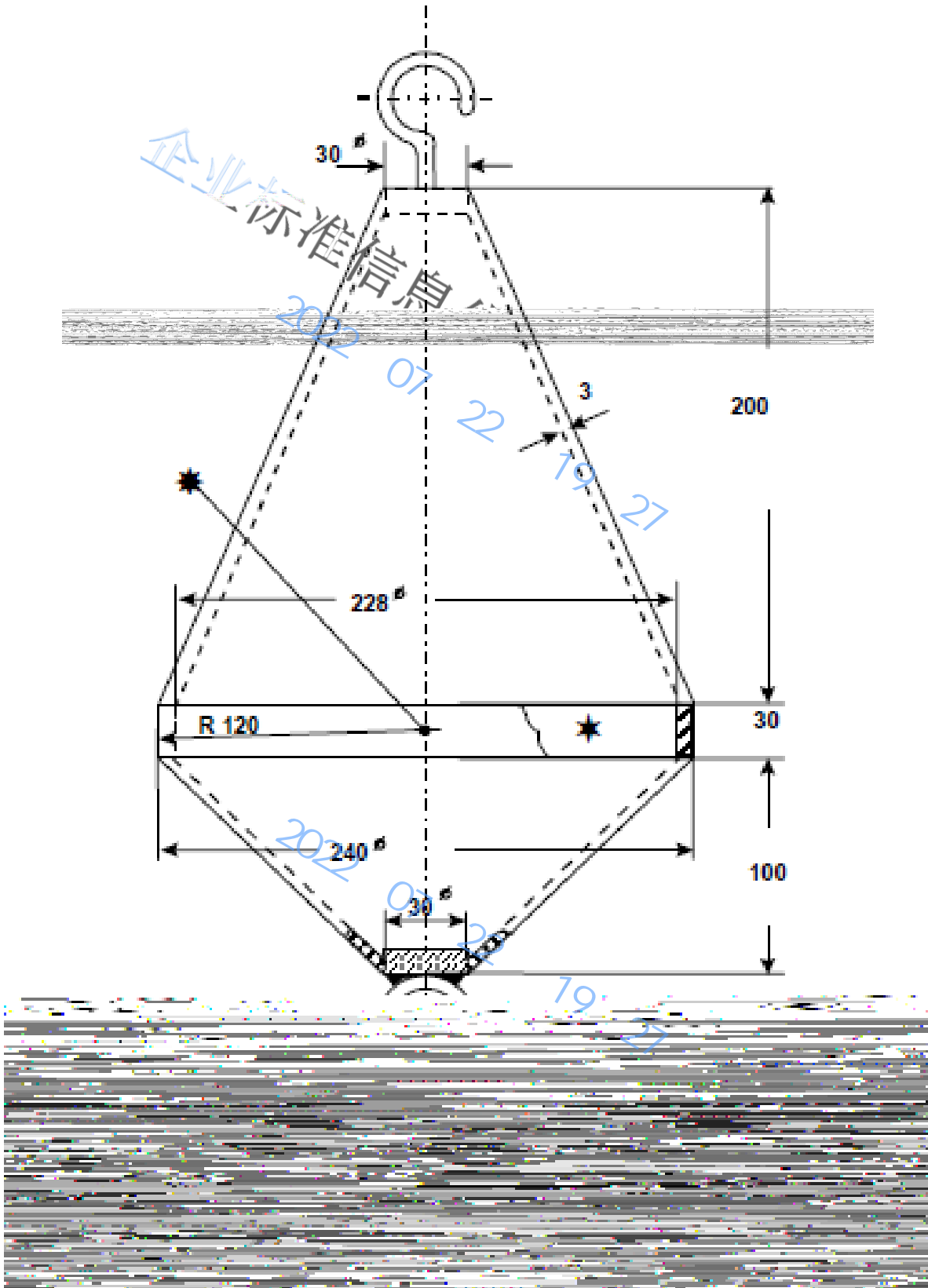

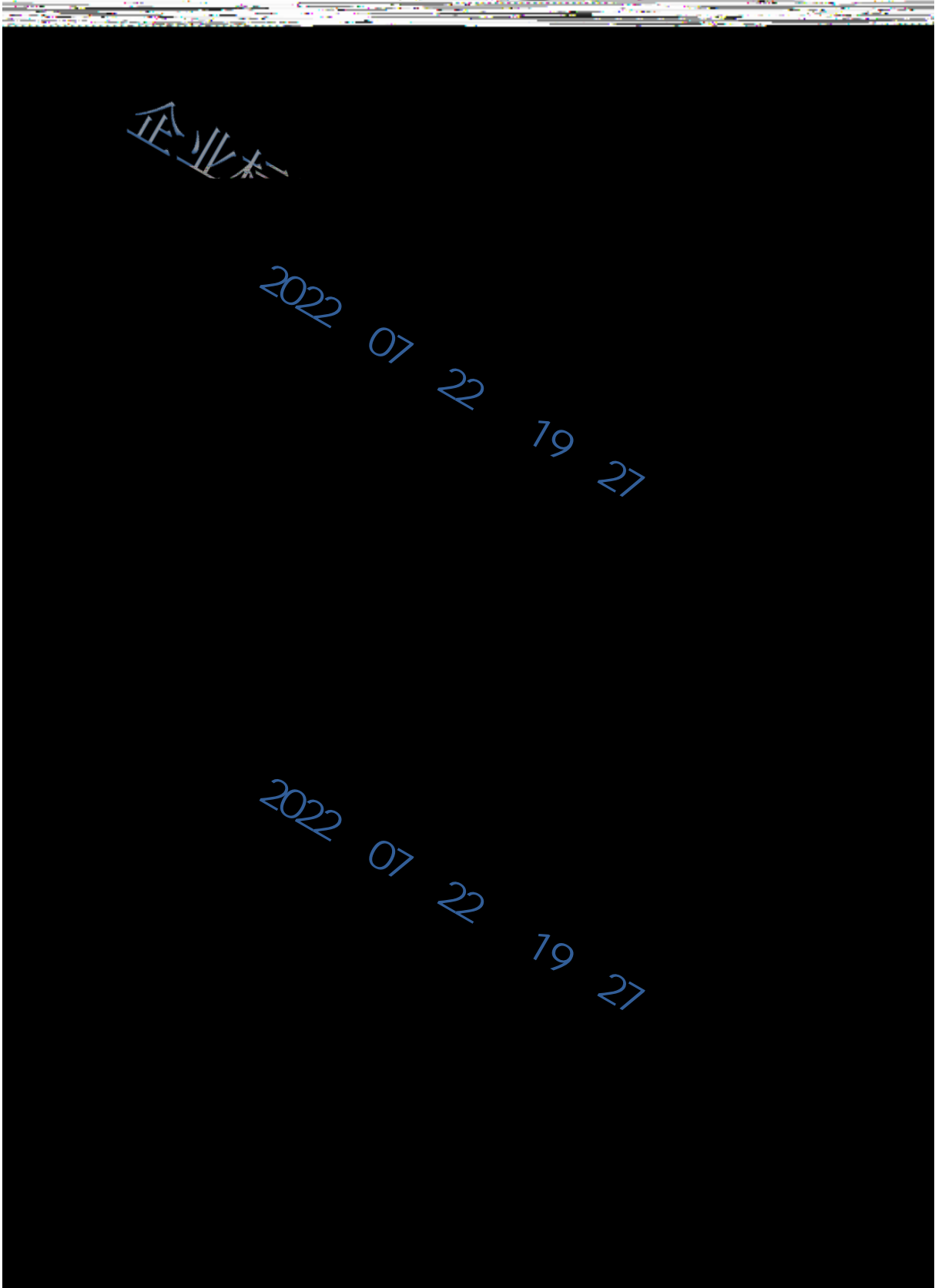

企业本

2022 07 22 19 27

2022 07 22 19 27

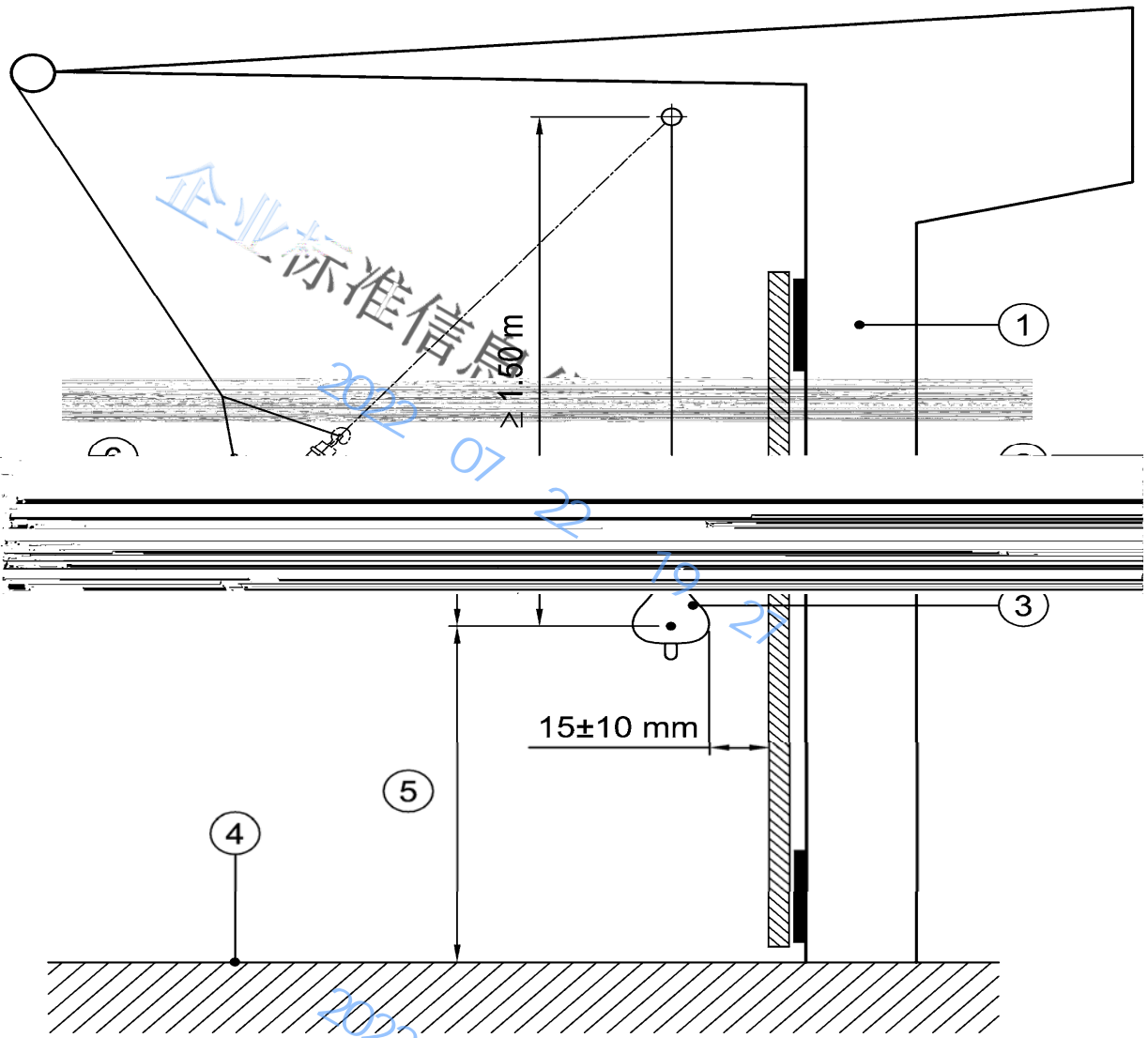

H—



1m

7.238

J2 4

J3



K
()

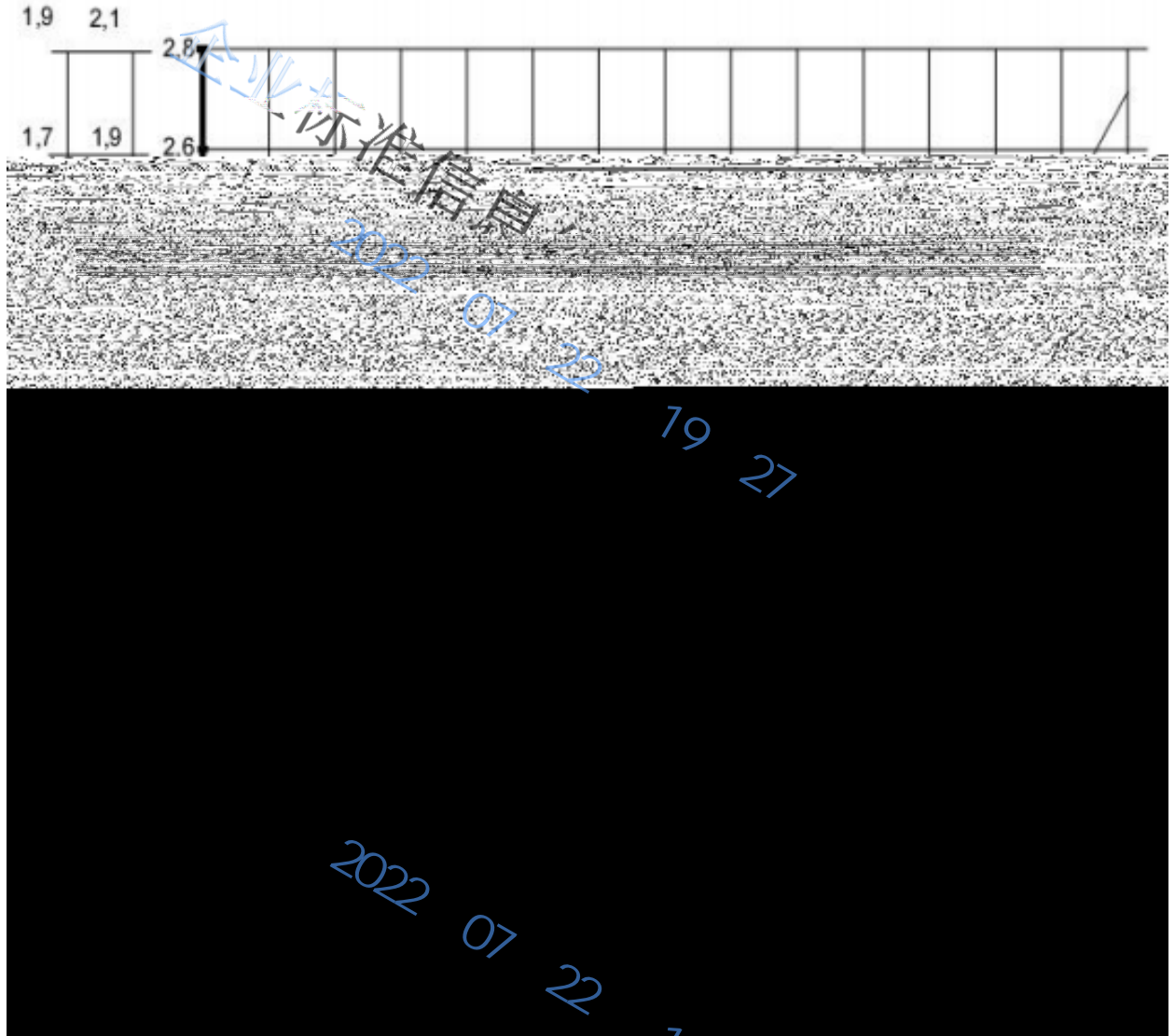

H m/s
 * m

5 7.3 1

**

5 7.1. 4

3 5m/s

K1

(5.7.1)



(L)

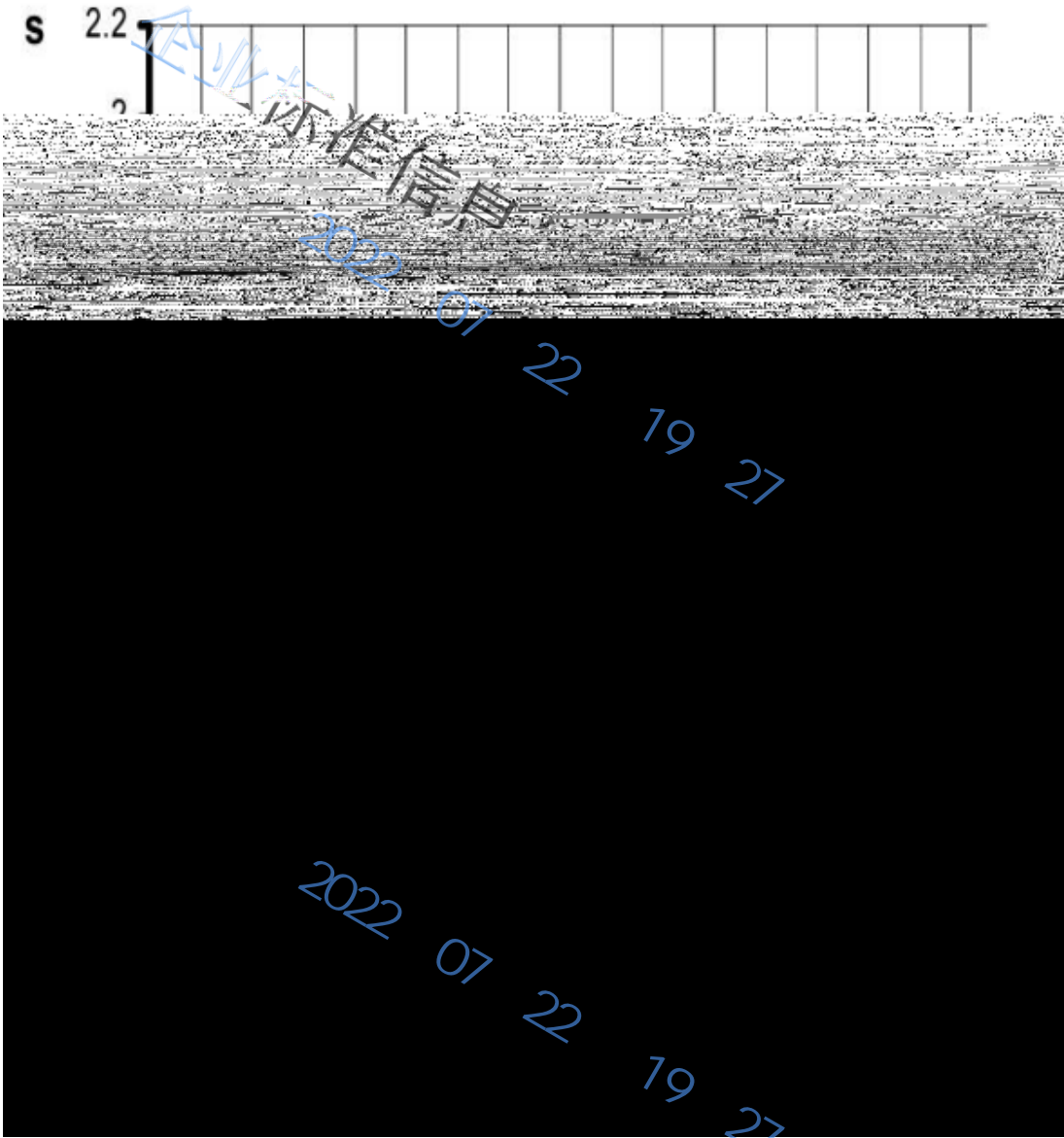

S

m

m/s

(10 4 1. 1) ()

(10 4 3 1)

50%

[10 4 3 2a]

1/3

[10 4 3 2b]

10 4 3

L1

(10 4)



(M)

M

- a)
- b)
- c)

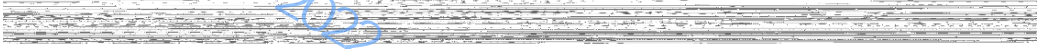

- a)
 - b)
 - c)
 - d)
- M

$T_1 < \dots$

$T_1 < \dots$

()

f

a

T1 T2

M 1 T1 T2

M 1.1

T1/T2

125%

1.25

8 2 2

8 2 2

M 1.2



T1/T2

a)

0.5 m/s²

b)

0.8 m/s²

M 1.3

T1/T2

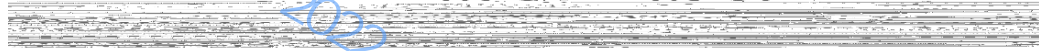

M 2

M 2.1

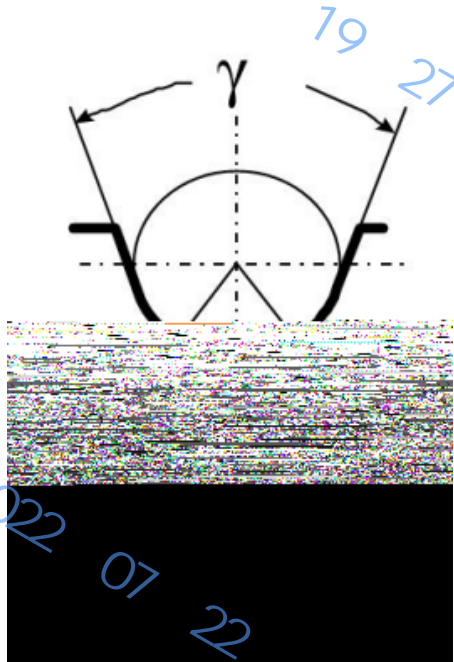

$$f = \mu \cdot \frac{4 \left(\cos \frac{\gamma}{2} - \sin \frac{\beta}{2} \right)}{\pi - \beta - \gamma - \sin \beta + \sin \gamma}$$

μ

1060(1.83)

80%



)
M2 1.2 V

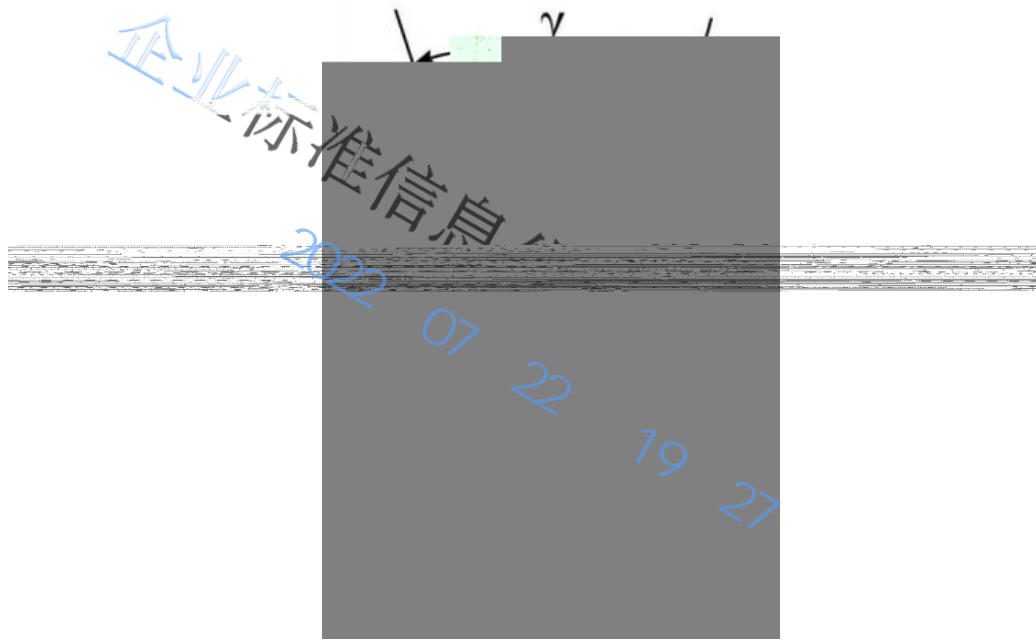

$$f = \mu \cdot \frac{4 \left(1 - \sin \frac{\beta}{2} \right)}{\pi - \beta - \sin \beta}$$
 , 对于未经硬化处理的槽;

$$f = \mu \cdot \frac{1}{\sin \frac{\gamma}{2}}$$
 , 对于经硬化处理的槽;

——轿厢滞留的工况:



1060(1.83)

80%

350

M2 2 2



0.12

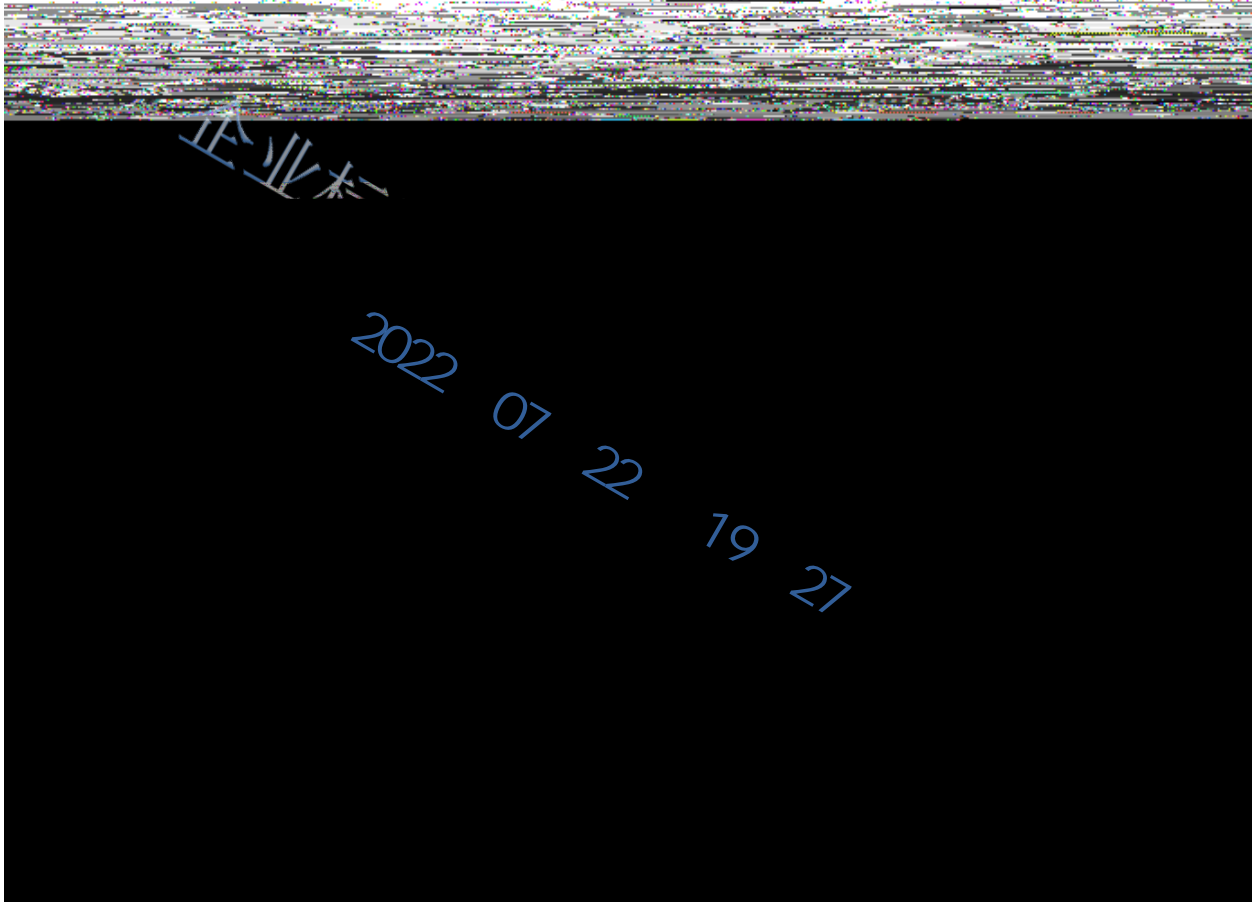

$\mu = 0,2$

MB

2022 07 22 19 27

ms

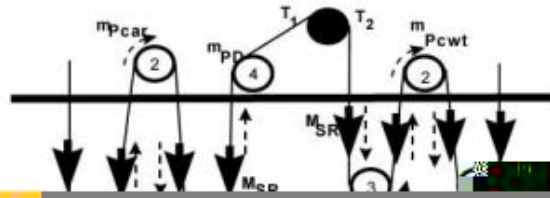

企业标准信息公共服务平台

2022 07 22 19 27

1

1

n_{pcar}
 n_{Pcwt}
 n_{PID}
 n_{IP}

J_{pcar}/R^2

J_{Pcwt}/R^2

$(2 \quad) J_{PID}/R^2$

J_{IP}/R^2

kg

kg

kg

kg



n_s
 n_c ()
 n_t
 P () ()
 Q kg
 M_{wt} kg
 M_{Rcar} [(0.5H y) × n_s ×] kg
 M_{Rcwt} M_{Rcar}
 M_{R} [(0.5H y) × n_c ×]
kg
 M_{Rcar} M_{R}
 M_{Rcwt} M_{R}
 M_{rav} [(0.25H 0.5y) × n_t ×]
 M_{omp} kg
 F_{Rcar} () N
 F_{Rcwt} () N
 H m
 y H/2 m
 T_1 T_2 N
 r () m/s^2
 g_n m/s^2
 i_{Pcar} ()
 i_{Pcwt} ()

 f
 a



(N)

Nl

9.2.2

St

a)

()

b)

c)

N2

N_{equi v}

(U V)

5% 6%

N_{equi v}

$$N_{equi v} = N_{equi v}(t) + N_{equi v}(p)$$

N_{equi v}(t)

N_{equi v}(p)

N2.1 N_{equi v}(t)

N_{equi v}(t)

Nl

U

N_{equi v}(t) 1

表 N1

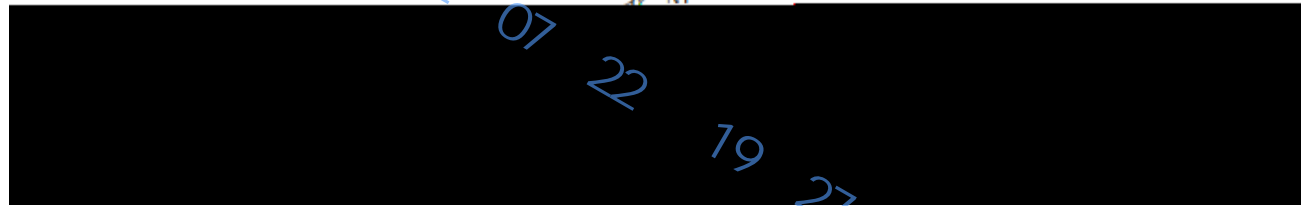

N2.2 N_{equi v}(p)

200

$$N_{equi v}(t) = K_p (N_{ps} + 4 \cdot N_{pr})$$

N_{ps}

N_{pr}

K_p



Dt
Dp
N3

Dt/dr

N4

N_{equiv}

N_2

例 1.

V 型槽, $\gamma=40^\circ$

$N_{equiv(t)} = 7.1$

$K_p = 2.07$

$N_{equiv(p)} = 2 \times 2.07 = 4.1$

$N_{equiv} = 11.2$

轿厢侧

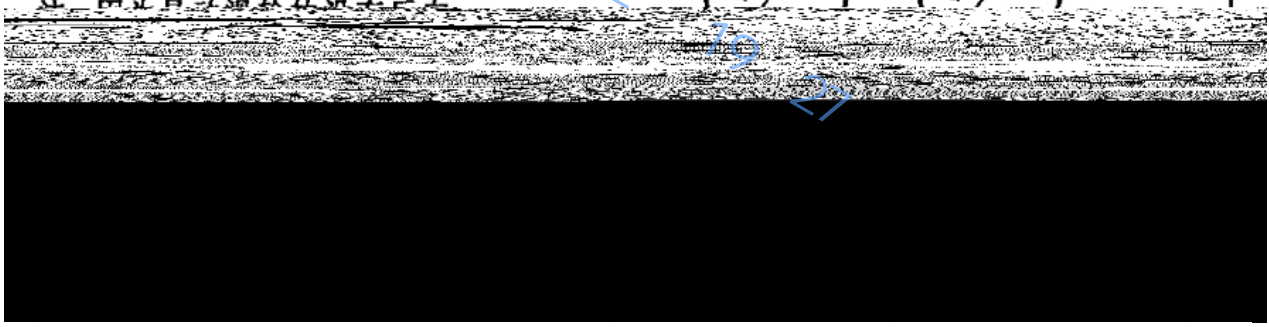
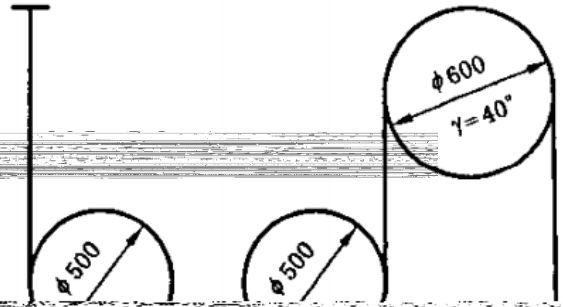

例 2.

V 型带切口槽

$\gamma=40^\circ$

$\beta=90^\circ$

$N_{equiv(t)} = 5.0$

$K_p = 5.06$

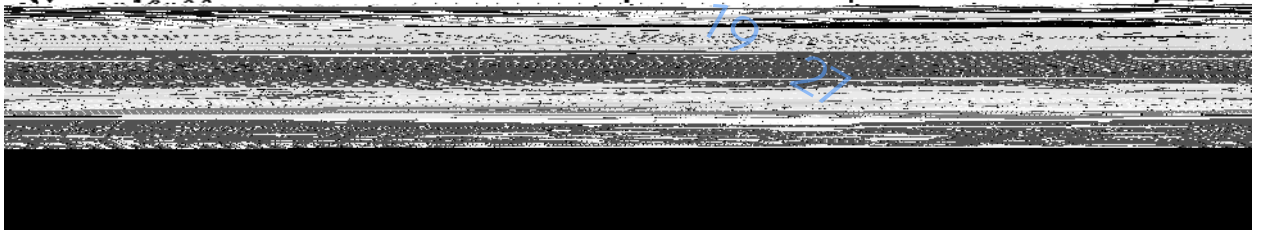
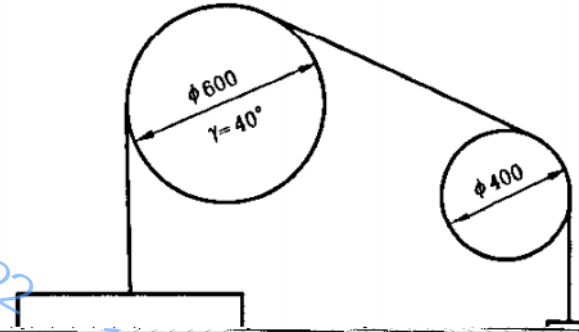

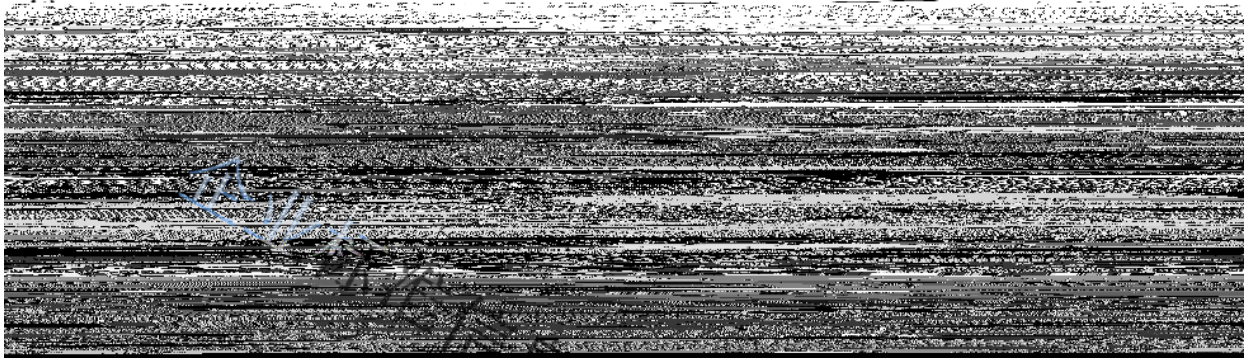

2022 07 22 19 27

2022 07 22 19 27